



# ULSTER COUNTY LOWER ESOPUS WATERSHED

Road-Stream Crossing Management Plan



A Program of the New York State Department of Environmental Conservation

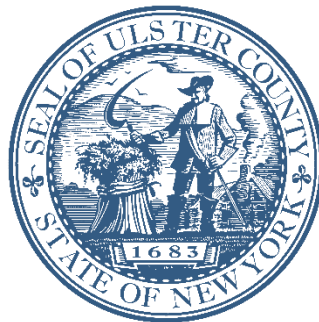

Ulster County Department of Environment

# Contents

Acknowledgement.....	3
Section 1: Introduction.....	5
1.1 Executive Summary.....	6
1.2 Project Background, Purpose, and Steps.....	6
1.3 MOSCAP.....	10
Section 2: Road-Stream Crossings.....	11
2.1 Streams.....	12
2.1.1 The Structure of Streams.....	12
2.1.2 How Streams Work.....	16
2.2 Indicators Road-Stream Crossings Need to be Replaced.....	19
2.2.1 Road.....	19
2.2.2 Structure.....	21
2.3 Indicators a Road-stream Crossing is Not Compatible with a Stream.....	24
2.4 Common Impacts to Streams.....	26
2.5 Dams.....	31
Section 3: Best Management Practices.....	35
3.1 General Recommendations.....	36
3.1.1 Build Road-Stream Crossings that Allow for Natural Stream Function.....	36
3.1.2 Keep Up to Date With the Latest Hydrologic Data.....	36
3.1.3 Track Maintenance and Replacement Projects.....	36
3.1.4 Consider Implementing Green Infrastructure Upstream of Undersized Structures.....	37
3.1.5 Climate Smart Communities Program.....	37
3.1.6 Flood Risk.....	40
3.2 Installing and Replacing Culverts.....	41
3.2.1 New York Stream Crossing Guidelines.....	41
3.2.2 Green Stormwater Infrastructure.....	44
Section 4: Culvert Prioritization.....	45
4.1 How to Use Data.....	46
4.1.1 Local ID & Survey ID.....	46
4.2 Navigating the Scoring.....	49
4.2.1 MOSCAP.....	49
4.2.2 DOT.....	49
4.2.3 NAACC.....	49

4.2.4 Geomorph .....	49
4.2.5 Highest Flood Risk (The Cornell Culverts Model) .....	50
4.3 Multi-Jurisdictional Hazard Mitigation Plan Projects .....	50
4.4 County Owned Bridges .....	52
4.5 Unsourced Metrics.....	53
Section 5: Funding & Resources.....	57
5.1 Federal Funding.....	58
5.2 State Funding.....	59
5.3 Local .....	62
Section 6: Appendices .....	63
A. Cornell Culverts Model Flood Risk Justification.....	63
B. NAACC.....	63
C. Glossary of Terms .....	63
D. Aquatic Connectivity (Hudson River Estuary Program) .....	63
E. Checklist for Municipalities Preparing for Funding.....	63
F. Stream Simulation Design.....	63
G. MOSCAP .....	63
H. Detailed Flood Analyses (FEMA) .....	63
I. HVA and LHCCD acknowledgement .....	63
J. Private Road-Stream Crossings.....	63
K. Dam Inventory .....	63
L. Bibliography .....	63

## Acknowledgement

Thank you to Cornell Cooperative Extension, and Ashokan Watershed Stream Management Program for the assistance in and completion of this project.

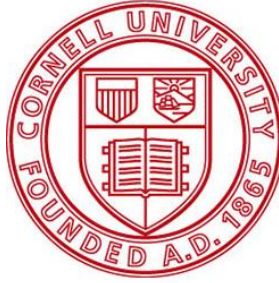

Ashokan Watershed  
Stream Management Program

This work was funded by NEIWPC [Contract #: 2019-021] and the Hudson River Estuary Program.



Hudson River  
Estuary Program

A Program of the New York State Department of Environmental Conservation

This document was prepared for the Hudson River Estuary Program, New York State Department of Environmental Conservation, with support from the New York State Environmental Protection Fund, in cooperation with the New England Interstate Water Pollution Control Commission. The viewpoints expressed here do not necessarily represent those of NEIWPC or NYSDEC, nor does mention of trade names, commercial products, or causes constitute endorsement or recommendation for use.





## 1.1 Executive Summary

---

## 1.2 Project Background, Purpose, and Steps

---

## 1.3 MOSCAP

---

---

## 1.1 Executive Summary

The Lower Esopus Watershed has 260 miles of streams, when the Sawkill (129 miles of streams and Plattekill (151 miles of streams) Sub-Watersheds that drain into the Lower Esopus Watershed are included, the total jumps to 540 miles of streams (derived from 1m County LIDAR). For the purpose of this document the Lower Esopus Watershed refers to the inclusion of the sub-watersheds. Streams and road systems are both linear networks, and where they intersect a bridge, culvert, or similar structure carries the road over the stream. These structures are commonly called road-stream crossings (RSX). As a road is built to accommodate different levels of traffic, streams form to accommodate the watershed and climate of their environment. Streams and roads function differently but need to coexist with one another. Road-stream crossings that are not built to carry a stream without altering its natural shape are more vulnerable to flooding, require more maintenance, and can significantly disrupt aquatic ecosystems.

Because streams and transportation networks are linear systems laid over each other, intersections are common. There are approximately 131 County-owned road-stream crossings in the entire Lower Esopus watershed. Many of these road-stream crossings are seasonal or year-round barriers to the movement of fish and wildlife. The results of ongoing research to identify flood risks and habitat barriers at road-crossings indicate that a significant proportion of these structures are management issues.

## 1.2 Project Background, Purpose, and Steps

### 1.2.1 Background

Ulster County Department of the Environment, in partnership with Cornell Cooperative Extension of Ulster County (CCE-UC), performed a multi-objective assessment of RSX within the Lower Esopus Watershed, including the Sawkill and Plattekill sub watersheds. This project included the development of several Town-wide RSX management plans (Town of Kingston, Town and Village of Saugerties, and Town of Woodstock), modeling of flood risk data, and engineering design of four County-owned RSX.

RSX in the Sawkill sub watershed were revisited using the Multi-Objective Stream Crossing Assessment Protocol (MOSCAP), a protocol developed by CCE-UC in the Ashokan watershed that builds on North Atlantic Aquatic Connectivity Collaborative (NAACC) to incorporate additional geomorphic and condition information during assessments. RSX in the Towns of Saugerties and Kingston were assessed for the first time using this expanded protocol. Collected field data were used to produce a

culvert inventory, GIS dataset, and ranking matrix to identify high priority RSX. Unconfirmed but predicted private road-stream crossings found by GIS desktop analysis are provided in map form in Appendix J.

Town and County municipal RSX management plans are linked to the following initiatives: a County-wide resilience planning process funded by the New York State Department of the Environment (DEC) Office of Climate Change, Lower Esopus stream management planning efforts, the Ulster County Multi-Jurisdictional Hazard Mitigation Plan, the New York State Climate Smart Communities Program, the Ulster County capital planning process, and the UC Transportation Council Transportation Improvement Program (TIP).

### **1.2.2 Purpose**

During storm events, RSX may fail catastrophically when floodwaters exceed the hydraulic capacity of a culvert and/or sediment and debris plug the culvert. The subsequent damage to road infrastructure and adjacent property can deliver large pulses of sediment to stream channels (Furniss et al. 1997; Nelson et al. 2012).

Additionally, road crossings can significantly fragment aquatic ecosystems, often resulting in substantial negative consequences. These improper crossings disrupt the movement of aquatic organisms, sediment transport, nutrient transport, and other critical ecological processes (NAACC, 2019).

This project assisted with a) identifying and assessing road-stream crossings b) having information on modeled flood risk based on the current RSX dimensions, and c) completion of conceptual and final designs for priority culvert replacements on County roads.

### **1.2.3 Project steps**

The project encompassed four phases: planning/engagement, assessment, design, and report preparation.

The Planning/Engagement Phase:

- Preparation and Acceptance of a Quality Assurance Project Plan (QAPP).
- Existing assessment data for previously assessed RSX were reviewed.
- For previously unassessed RSX, existing information about the surrounding location and condition was gathered, GIS analysis of stream crossing location was completed, and survey methods were finalized.

- Field work prioritization was completed.
- Stakeholder engagement strategy was finalized; kick-off and stakeholder meetings were scheduled.

#### The Fieldwork Phase:

- A one-week training for technicians was delivered by Cornell Cooperative Extension of Ulster County staff on survey methods and geomorphic stream features, additional training on NAACC protocols was then followed by four months of site visits to RSX locations.
- Assessments at each site included collection of over 60 metrics covering structural material, crossing dimensions (length, width, height, slope), water depths, outlet drops, erosion, sediment, deposition, etc.
- Aquatic organism passage was assessed using the North Atlantic Aquatic Connectivity Collaborative (Jackson and Abbott 2015) survey protocol to provide continuity with stream crossing assessments.
- Geomorphic assessments were completed using the Vermont Culvert Geomorphic Compatibility Screening Tool (Vermont Natural Resources and MMI 2008).
- Structural assessments combined condition metrics included in the NYS Department of Transportation Culvert Inventory and Inspection Manual (NYSDOT 2006) and NAACC.
- Determinations in the field included whether a site was accessible or not, whether the road was private or public, or whether or not other barriers or safety issues prevented access. Missing data may be explained by these determinations. For example, if the outlet of an RSX was not accessible due to barbed wire fencing protecting private property, data like outlet width and height, and slope percent of the crossings were most likely not recorded.

#### The Design Phase:

The County used existing assessment data to identify a list of potential culverts for conceptual design. In consultation with grantors and The County's Department of Public Works, four sites were selected for engineering design services (3 conceptual designs and one final design, a total of four sites).

#### The Report Preparation Phase:

Municipal RSX plans were produced. The project team extended the assessment results through stakeholder meetings with stakeholders. Hardcopy and electronic



reports, as well as a GIS database and matrix, were shared so that all information collected can be used by municipalities for planning, replacement, and emergency purposes.

#### **1.2.4 Project Team**

NEIWPC:

Peter Zaykoski, QA Program Manager: Reviews and approves the QAPP and all future versions for the project.

Hudson River Estuary Program/NEIWPC:

Megan Lung, Environmental Analyst

Responsible for reviewing QAPP, receives all quarterly reports. Serves as project Lead Coordinator. Point of communication for the Hudson River Estuary Program. Reviews NAACC data submissions.

Ulster County

Amanda LaValle, Coordinator: Responsible for overall project management and budget and maintaining the QAPP, QA Manager.

Benjamin Ganon, Environmental Resource Technician: Responsible for collecting and entering field assessment data, writing management plans and reporting.

Chris Johnson, Intern: Responsible for collecting and entering field assessment data.

Cornell Cooperative Extension of Ulster County, Ashokan Watershed Stream Management Program (AWSMP)

Tim Koch, Stream Educator: Responsible for training field technicians and QA Manager of geomorphic and structural data.

Leslie Zucker, Program Leader: Responsible for contract management and budget concerning the Cornell sub-agreement.

Kiah Parmelee, Field Technician: Responsible for collecting and entering field assessment data and writing management plans.

### 1.3 MOSCAP

The assessment protocol used in the field by the field crew is called the Multi-Objective Stream Crossing Assessment Protocol, or MOSCAP. MOSCAP was developed by Tim Koch (Cornell Cooperative Extension, Ashokan Watershed Stream Management Program) in 2018 in partnership with Ulster County Soil and Water Conservation District and NYC Department of Environmental Protection. The objective of MOSCAP is to perform a rapid, yet comprehensive field assessment of road-stream crossings to yield a RSX inventory.

MOSCAP is made up of four distinct and pre-existing protocols; three of which are examined in the field, and one of which is a modeling component. These protocols are combined into one rapid field assessment. The three protocols that are used in the field are the Vermont Stream Geomorphic Assessment (Vermont Agency of Natural Resources 2009) which examines geomorphic processes, structural condition of the RSX using the NYSDOT Culvert Inventory and Inspection Manual (NYSDOT 2006), and the North Atlantic Aquatic Connectivity Collaborative (NAACC) Stream Crossing Instruction Manual for Aquatic Passability Assessments in Non-Tidal Streams and Rivers (NAACC Version 1.3) which assesses aquatic connectivity. The fourth component is a flood flow capacity model called “The Cornell Culverts Model” (Cornell Water Resources Institute 2018) which models flow capacity using dimensions from NAACC during different current and future return intervals.

Data from each component are merged in Excel and through a customizable scoring algorithm, each site is given an overall score, which then can be used to prioritize and rank RSX. The scoring algorithm can be adjusted based on stakeholder priorities, for example if aquatic connectivity or structural condition is deemed more important, the weights can be adjusted accordingly and generate a refreshed ranked list.

## Section 2: Road-Stream Crossings

Road-  
Stream  
Crossings

---

### 2.1 Streams

---

### 2.2 Indicators Road-Stream Crossings Need to be Replaced

---

### 2.3 Indicators Road-Stream Crossing is Not Compatible With the Stream

---

### 2.4 Common Impacts to Streams

---

### 2.5 Dams

---

Section 2 explains road-stream crossings. First, section 2.1 describes how streams work: the structure of streams, what forces control them, and basic terminology of streams that can aid in understanding road-stream crossings. The next two sections describe indicators seen in the road and structure of the crossing that determine it may need to be replaced and indicators the road-stream crossing may not be compatible with the stream. Section 2.4 delves into scenarios that may be encountered in the field if the road-stream crossing is interfering with the nature stream channel. The last section inventories the dams located in the Lower Esopus Watershed as well as other important information on dams; such as how dams can impact streams and aquatic organisms, how owners can maintain their dams, and why dam failures occur.

## 2.1 Streams

Streams are complex, dynamic systems that do complicated work. The work of streams is the collection and movement of water, sediment, and debris from the surrounding landscape. The shape of streams change with time as erosion, deposition, and transportation of sediment occurs. The following section explains the structure of streams.

### 2.1.1 The Structure of Streams

#### **Streambed and Channel**

The streambed is the foundation of a stream and supports its banks. Streambeds are composed of a variety of materials. The size ranges from large materials like bedrock, large boulders, and rocks, to smaller materials like gravel, sand, silt, and clay particles. The scouring and depositing of these materials shape the stream channel and its floodplain. The structure of a channel is described by the following: length of meandering or curving (pattern), width and depth of the channel (dimension), and the degree of slope (profile).

#### **Meanders**

The processes of erosion and deposition serve to lengthen a channel through a curving process known as “meandering”. Meanders are essentially curves. As shown in Figure 1, while water flows around a curve, the outer edge of the water is flowing faster than the inner edge. The increased velocity of the water causes bank erosion on the outer section of the curve (cutbank) and removes material. The decreased velocity of the water on the inner part of the curve encourages sediment to drop out of the slower moving water resulting in the deposition of material, usually of the smaller sort, like sand and gravel, along this bank (point bar). Curves slow down the water and absorb energy, which helps reduce the potential for erosion.

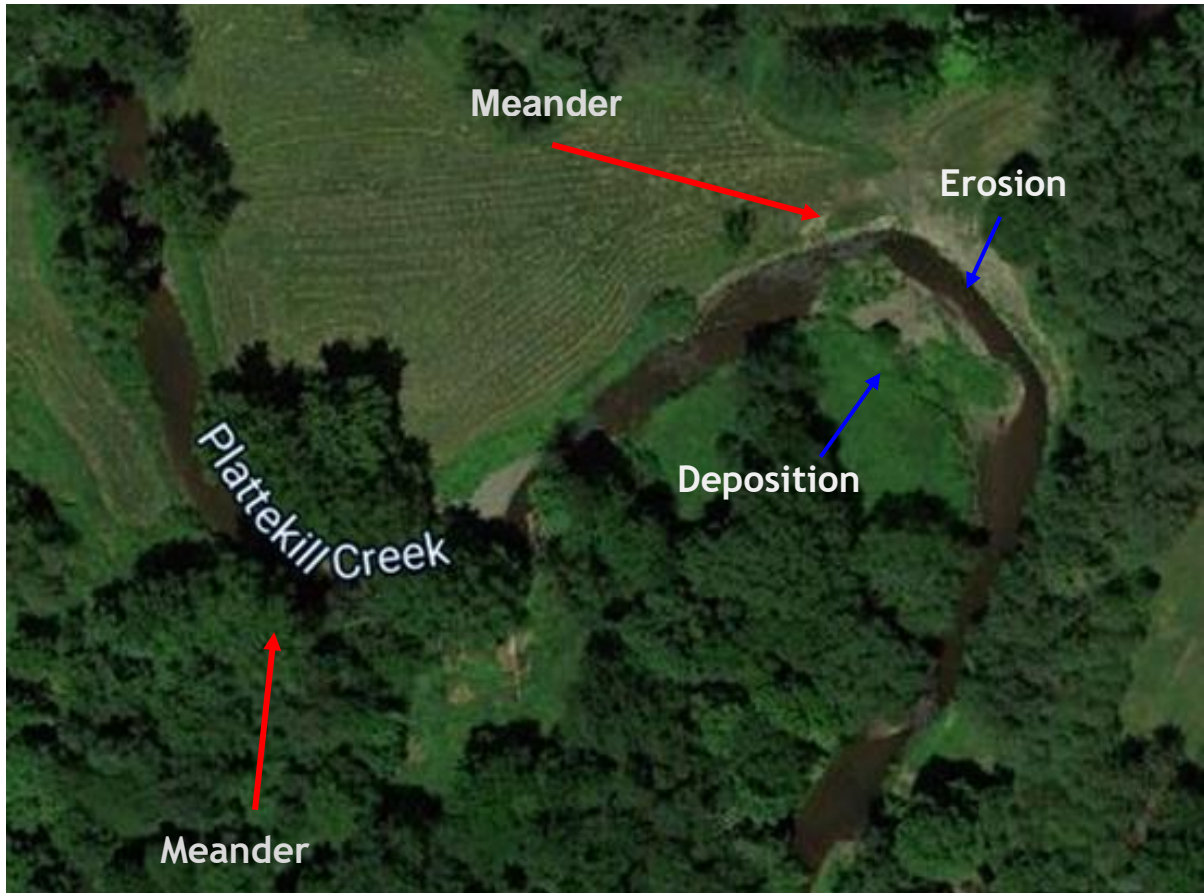

FIGURE 1: A BIRDS EYE VIEW OF TWO MEANDERS WITHIN THE PLATTEKILL CREEK. DEPOSITION WILL OCCUR ON THE INNER PART OF THE CURVE WHILE EROSION WILL OCCUR ON THE OUTER PART OF THE CURVE.

### Slope

Slope is the change in elevation or steepness of a streambed. Streams with higher slopes have higher gradients, straighter channels, and a more rapid movement of water; while streams with lower slopes have lower gradients, more meanders, and more slow-moving water.



## Pools, Steps, and Riffles

Streams alternate between concentrated (convergent) flows and flows which are more spread out (divergent). Convergent flows are deeper, faster and more erosive. Pools are deeper areas that were scoured out during high flow events. As water flows over the pool, the velocity of the flow decreases and sediment is dropped towards the end of the pool. This creates a riffle. This alteration between bed erosion and deposition creates “bed forms”. These bedforms help manage the energy held by a stream. Streams are often classified by these bedforms (i.e. pool-riffle or pool-step streams). Figure 2 and Figure 3 display each of these stream features.

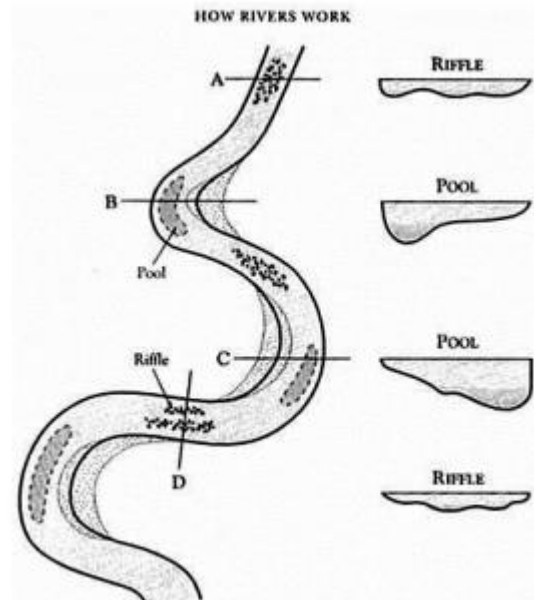

FIGURE 2: A GRAPHIC DEPICTING DIFFERENT BEDFORMS STREAMS ARE MADE OF.

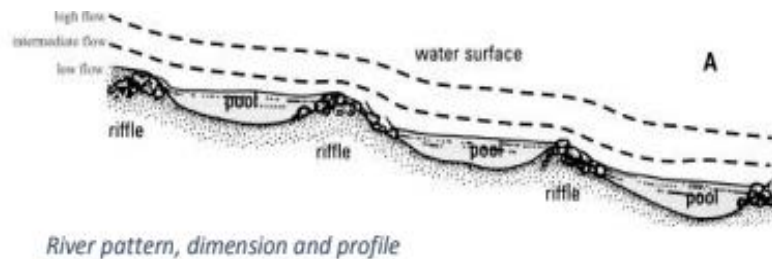

FIGURE 3: A LONGITUDINAL PROFILE SHOWING A SEQUENCE OF DIFFERENT BEDFORMS.

## Stream Reach

A segment of a stream with similar physical characteristics throughout its length.

## Riparian Area/Riparian Buffer/ Riparian Zone

The interface between land and a stream. This transition acts like a buffer and includes vegetation, wildlife, and other natural features. It can benefit streams in several ways: the roots of vegetation stabilize streambanks, vegetation filters sediment and excess nutrients, and the tree canopy provides shade to cool water temperatures. Riparian zones can also help dissipate a stream's energy. See Figure 4 for an example.

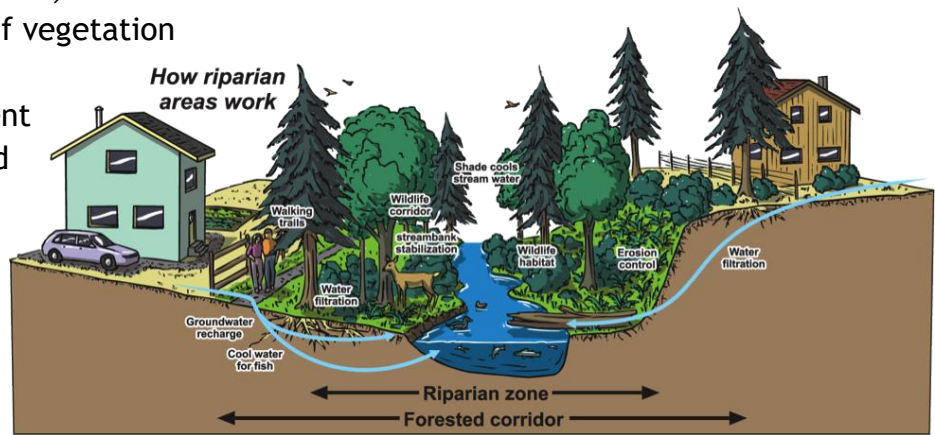

FIGURE 4: A GRAPHIC DEPICTING A RIPARIAN ZONE. GRAPHIC SOURCE: REGIONAL DISTRICT OF NANAIMO.

## Floodplain

Flat areas of land adjacent to the stream. These areas consist of stream sediment and are separated from the channel by a stream bank. Floodplains provide a place for water to go when it cannot be contained in the channel, such as during spring thaw or heavy precipitation events, and are subject to flooding.

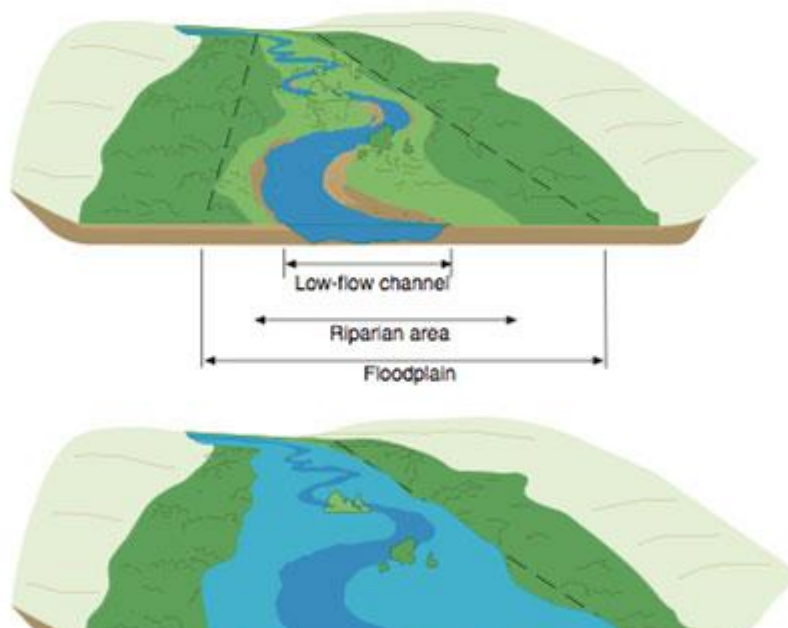

FIGURE 5: A GRAPHIC DEPICTING THE FLOODPLAIN OF A STREAM. GRAPHIC SOURCE: ASHOKAN WATERSHED STREAM MANAGEMENT PROGRAM.

## Stream Corridor

Stream corridors consist of the channel, floodplains, and adjacent lands. Streams should be able to meander freely, allowing for sediment and the energy of flowing water to be distributed more evenly. These are complex ecosystems that provide an avenue for wildlife movement and other important natural processes.

## Active Channel Width

A measurement included in the MOSCAP survey used to complete this culvert project is active channel width. Active channel width is defined as the width of the stream channel that is most frequently affected by higher flows. It is greater than the wetted width of the channel but smaller than the bankfull width. Indicators of active channel width may be a break in slope of the stream banks, sudden sediment size change in the stream banks, a wrack line, or change in vegetation from herbaceous to woody. There are several other indicators of active channel width.

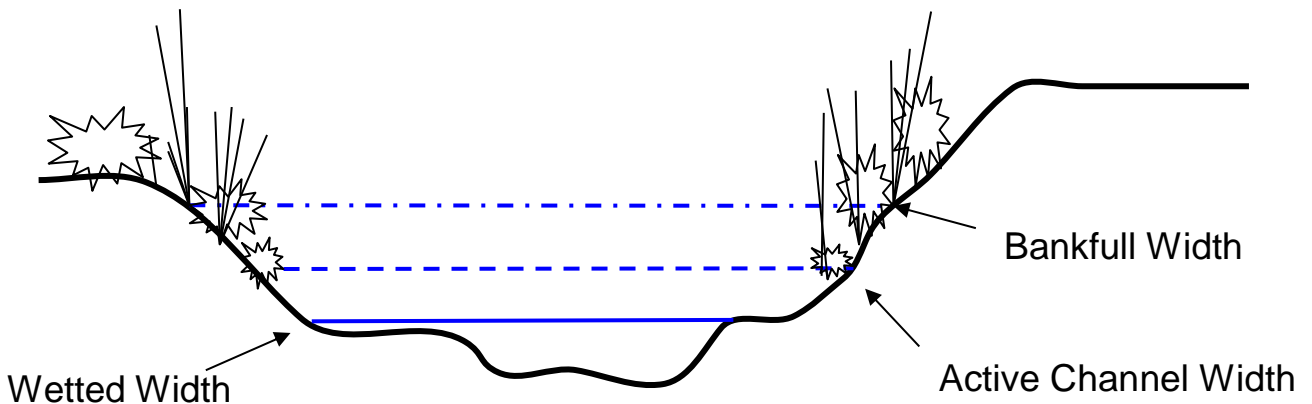

### 2.1.2 How Streams Work

The process of moving water and sediment downhill contains a large amount of energy. The stream dissipates such energy through the formation of channels. Structures like floodplains, meanders, and bed forms within channels help uniformly spread a stream's energy and sediment load. Streams are in a state of dynamic equilibrium- constantly adjusting to keep their energy in a state of balance. Multiple factors describe this process and are defined in the section below.

### Kinetic Energy/Friction/Base Flow/ Storm Flow

Kinetic energy is the energy of movement. As water flows downward, the energy is converted from potential energy to kinetic energy.

### **Friction**

Friction is a way streams can dissipate their energy. A large amount of energy is lost this way. The roughness of a stream bed, banks, and floodplain creates friction. This roughness includes things like rocks, wood, and vegetation in the channel or floodplain.

### **Stream Flow**

Stream flow is the amount of water carried by a stream. The amount can vary and is influenced by several factors, like the time of year (ephemeral streams) and amount of precipitation. Precipitation mainly reaches streams in two different ways: base flow or storm flow.

### **Base Flow**

Base flow is water that infiltrates the ground where it contributes to groundwater flow. The source of water is rainwater and snowmelt. After it infiltrates the ground, it slowly moves through the bedrock and soil to contribute to base flow. This provides a steady supply of water to many streams and rivers.

### **Storm Flow**

Rainfall and snowmelt that flows through a watershed using the land surface or near-surface soil. This is the main component of high stream flows during rainy weather and spring snowmelt and is dependent on precipitation patterns and watershed characteristics.

### **Sediment Transport**

Stream energy that is not used by kinetic motion and friction is available for transporting sediment. The sediment is supplied from the surrounding landscape and the erosion of the bed and banks.

## Dynamic Equilibrium

Streams exhibit a dynamic form of stability. They are in a state of balance between continuing processes. Streams are moving and changing, but generally in a slow and predictable manner. They can maintain their dimensions, pattern, and profile without dramatic changes in the pattern of its erosion and deposition processes. When a natural stream develops an equilibrium depth and

slope, the shape of its channel is determined by the coarseness of the sediment in its bed, the soil cohesiveness and soil binding properties of vegetative root systems on its banks. See Figure 6 for a brief explanation of Lane's balance.

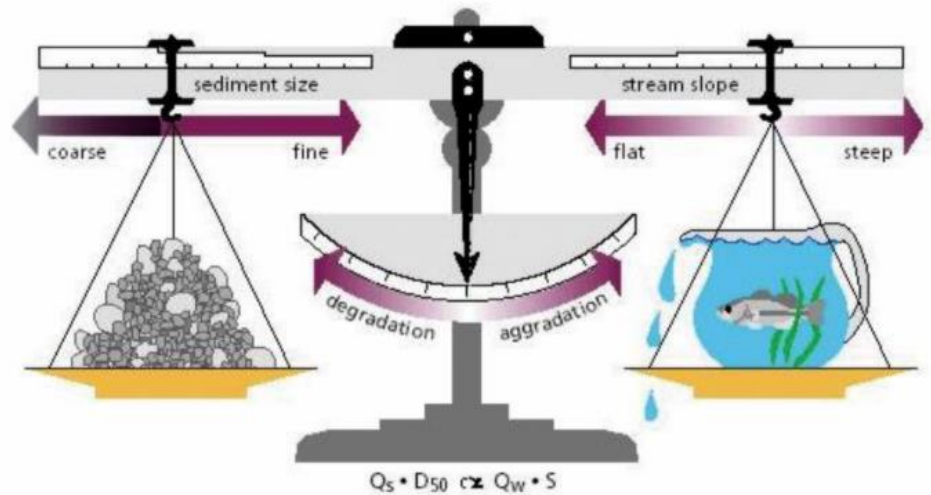

FIGURE 6: A GRAPHIC DEPICTING LANE'S BALANCE, WHICH DESCRIBES HOW CHANGES IN SEDIMENT LOAD, SEDIMENT SIZE, SLOPE, AND DISCHARGE DETERMINE WHETHER A STREAM SYSTEM WILL AGGRADE OR INCISE.

## How Channels Change Their Shape

Streams in dynamic equilibrium are considered to be stable. They experience small-scale adjustments but are generally consistent in respect to their channel dimensions, pattern, and profile. Streams erode their banks and migrate over time across their floodplains but are still considered to be stable. Consequential changes in channel shape are due to large-scale events, like major floods and human intervention into the stream corridor.

## Reference Condition

- **In Adjustment:** The term “in adjustment” refers to a stream reach where the channel structures and stream processes have deviated from the expected natural conditions. These unstable stream segments haven't evolved into a completely new stream type.
- **Poor condition:** The term “poor condition” refers to a stream that is in “disequilibrium” and is departing from its stream type. The stream reach is



exhibiting a new stream type and would need to go through extreme adjustments until it evolves back to the reference reach.

Because streams compose one-half of a road-stream crossing, it is imperative to understand how they work to manage road-stream crossings correctly. Streams are dynamic, complex systems that go through a multitude of processes involving the transportation of sediment and water. They change and maintain their shape through erosion and deposition.

## 2.2 Indicators Road-Stream Crossings Need to be Replaced

### 2.2.1 Road

Deteriorating roads are oftentimes a sign that the road-stream crossing is inadequate. The three components that help determine the overall condition of the road are the pavement condition, settlement condition, and the embankment condition.

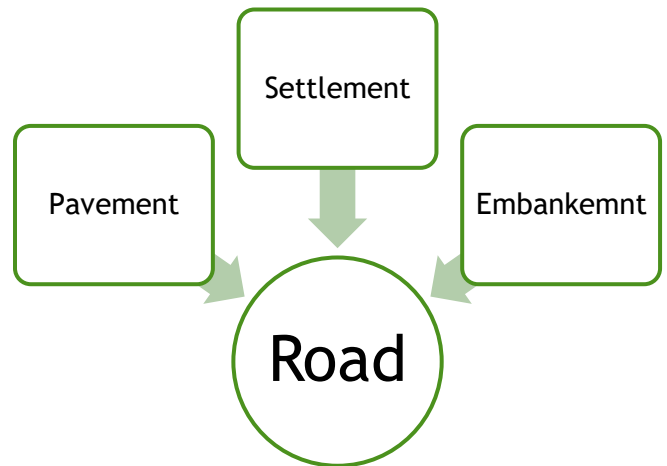

#### Pavement

Each pavement type will show signs of deterioration in different ways and are as follows:

- Asphalt pavement: Rutting, potholes, and general disintegration.
- Concrete pavement: Craving, delamination, and spalling.
- Gravel surfaces: Rutting, potholes, and loss of the center crown of the road.
- Wood bridge decks: Rot, splintering, warping, and material loss will occur in the deterioration process.



An example of road deterioration on Atwood Road. Local ID: LEW\_029

The riding quality will also decline in roads that are inadequate. Roads may be rough and have grooves in the wheel path that may trap water and lead to hydroplaning (Tim Koch 2018).

## Settlement

Settlement refers to the degree of differential settling of the road surface relative to the crossing structure. It is intended to rate the smoothness of the transition from the approach roadway to the crossing structure. Evidence of differential settling is as follows:

- A noticeable dip or bump in the road that is felt when driving across the road-stream crossing.
- Cracking and breaking of the pavement.

A straightedge laid across the structure longitudinally over the approach pavement is useful for observing settlement (Tim Koch 2018).



An example of settlement on Lucas Ave. Local ID: LEW\_040

## Embankment

The roadway embankment is the slope that rises from the stream to the road surface. The stability of the embankment is the main consideration. Indicators of poor embankment are (Tim Koch 2018):

- Settlement and/or sloughing of side slopes. This can result in a convex appearance of the side slope or abrupt changes in the side slope suggesting failures.
- Soil cracks perpendicular to the slope or abrupt changes in the side slope.
- Guide rail posts out of plumb and leaning outward and down the slope.
- Vertical displacement of guide rail and posts.

Pavement, settlement, and embankment condition all influence the overall road condition.



An example of a detonating embankment on Kripple Bush Davis Corners Road. Local ID: LEW\_041

### 2.2.2 Structure

As road-stream crossings age, signs of aging and deterioration will be apparent in the structure. The following section discusses indications of weakening structure in road-stream crossings.

#### Span Barrel Condition

The span barrel is considered the inside of the structure where water flows from the upstream inlet to the downstream outlet. The assessed components will differ based on the type of structure being observed.

For plastic, metal, or concrete pipes (round, elliptical, arch), observable deterioration is on the inside of the pipe. They include:

- Irregularities or deformities in the shape
- Section loss, corrosion, and abrasion
- Failing span barrels would have significant to extreme distortion, severe isolated corrosion or pitting, widespread moderate section loss, significant cracking along seams, and soil infiltration into structure

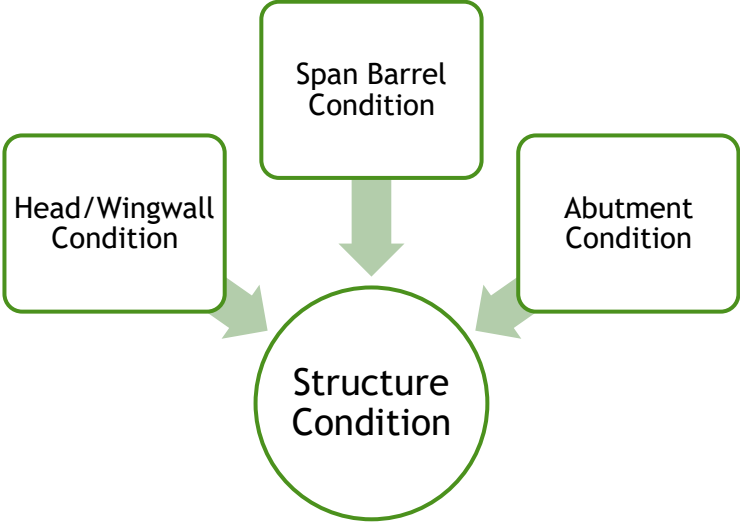



An example of a span barrel on Atwood Road. Local ID: LEW\_032

For box culverts and open bottomed arches, the deterioration would occur on the ceiling slab. Defects are:

- Cracks, spalls, and delamination of material
- Vertical/horizontal misalignment
- Differential movement or settlement at joints between sections
- In severe cases, extreme deterioration, differential movement or settlement of span barrel (Tim Koch 2018).

For all bridges, the primary members, slabs, and the structural deck will have observable deterioration. Indications of deterioration include:

- Corrosion, cracks, delamination, distortion, and section loss of any steel girders
- Cracking, efflorescence, spalling, and exposed rebar in any slabs
- Deck leakage
- A failing span barrel on a bridge would have severe section loss on steel girders or severe impact damage to structural members, heavy spalling or efflorescence on deck, and/or structural components rendered ineffective by deterioration or impact damage (Tim Koch 2018).

### **Abutment Condition**

Bridges and box culverts will have abutments. General signs of deterioration are:

- Vertical and/or horizontal misalignment
- Differential movement or settlement at joints between sections
- Joint separation



- Leakage
- Cracks, spalls, and delamination
- In severe cases, abutments would have deterioration, differential movement or settlement so severe failure has occurred or is imminent (Tim Koch 2018).



An example of abutments on Wynkoop Road. Local ID: LEW\_021

### Headwalls and/or Wingwalls Condition

If applicable, it's important that the headwall and wingwalls have the ability to retain the embankment material and support the guardrail. Deterioration of structure includes:

- Movement of the headwall/wingwall from its original location, along with associated effects on the embankment and/or guide rail can happen.
- Cracks, spalls, and delamination
- A failing headwall or wingwall would be severely deteriorated and movement is so severe that either the headwall or wingwall no longer supports the embankment or guide rail (Tim Koch 2018).



An example of headwalls and wingwalls on Hurley Mountain Road. Local ID: Lew\_018



Maintaining the structural condition of a road-stream crossing is imperative to creating resilient and functioning infrastructure within a community. While the structural components that make up road-stream crossings can differ, the weakening of them will cause the same outcome: a failing road-stream crossing. Failure of a road-stream crossing can be catastrophic and endanger a local community by leading to a higher flood risk, closure of roads, as well as blocking passage of aquatic organisms. Therefore, it is crucial to look for signs of deterioration in any of the structural components within a road-stream crossing.

## 2.3 Indicators a Road-stream Crossing is Not Compatible with a Stream

For a road-stream crossing to be compatible with the stream, it will pass the stream without interfering with any natural process of the stream. Road-stream crossings that are not compatible with the stream will display common indicators. These indicators are discussed in the section below.

### 2.3.1 Degradation, Incising, Scouring Down

These situations are a result of a stream having excess energy. The stream has more than enough energy needed to transport sediment and begins to erode into its bed or banks. Degradation is most

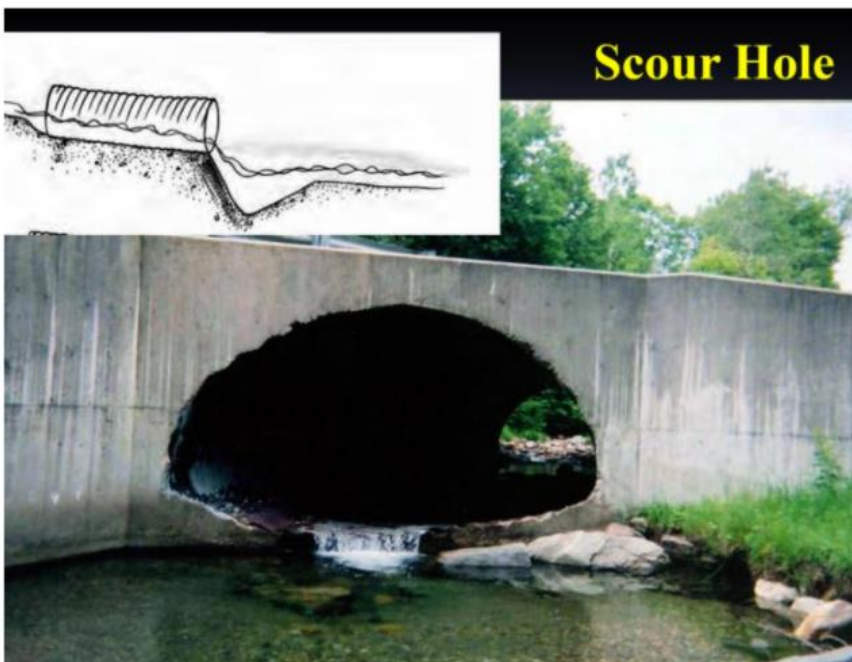

FIGURE 7: SCOUR HOLE DOWNSTREAM OF AN UNDERSIZED CULVERT. PHOTO SOURCE: UMASS RIVER AND STREAM CONTINUITY PROGRAM.

visible in actively eroding banks or headcuts and is common at the downstream end of undersized culverts. A headcut is a small waterfall, often resulting from the deepening of a channel caused by dredging, excavation, or increased stream erosive power downstream of a natural or human caused constriction. Sometimes degradation is confined to one spot right below an undersized culvert as the culvert serves as grade control. This is called a “scour hole” and it can turn into a very wide, deep hole that

undermines adjacent stream banks. These “perched” culverts then block the movement of fish and wildlife upstream. In situations where a head cut is uncontrolled, the headcut and associated erosion will migrate upstream until it is stabilized.

### 2.3.2 Aggradation and Lateral Adjustments

When a stream does not have enough energy to transport its sediment load, it will

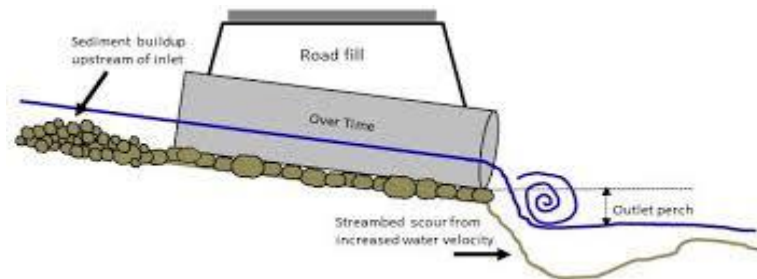
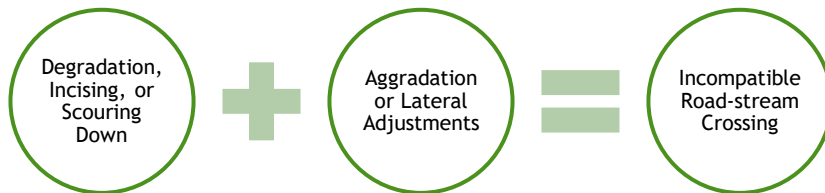

FIGURE 8: A GRAPHIC DEPICTING DEPOSITION AND SCOURING OCCURRING IN AN UNDERSIZED CULVERT. GRAPHIC SOURCE: UNH EXTENSION.

deposit sediment in its channel through a process called “aggrading”. As the streambed rises, the water spreads out, eroding laterally (lateral width adjustments), and thus widening the channel. When moderate to extensive vertical adjustments of the stream channel have been set in motion, a stream is in disequilibrium and the channel has the capacity to evolve. Road-stream crossings that constrict the natural channel can have multiple effects on the stream channel; one of them being aggradation, which commonly occurs upstream of



the crossing. The hydraulic capacity is reduced from the constriction as sediment and debris block the inlet of the crossing. As well as aggradation, erosion of adjacent stream banks is common. The rate of change in a stream channel relies on several factors: the erodibility of the bed and bank materials, the supply of sediment, and the frequency of flooding. For example, a stream bed with non-cohesive banks (i.e. gravel) in a watershed that has flash floods often will evolve in a smaller amount of time compared to a streambed that has more cohesive banks (i.e. clay) where flooding has not occurred very often.

While in the field monitoring road-stream crossings, it is important to look for each of these features: degradation, incising, scouring down, aggradation, or lateral adjustments. Each feature may look different, but all result from the same problem:

the road-stream crossing is not compatible with the stream. A road-stream crossing should be able to pass a stream without interfering with a stream's natural process. If a road-stream crossing is compatible with the stream, it will not display any of the indicators discussed above.

## 2.4 Common Impacts to Streams

Road-stream crossings can be extremely disruptive to stream equilibrium and aquatic organisms if not designed to pass the natural stream channel without interrupting the natural process. As well as harming ecological integrity, road-stream crossings that do not mimic the natural stream channel can pose risks for human safety by being a flood risk. Below are some common impacts associated with road-stream crossings and how they relate to stream structure and function:

### Undersized Crossings

A crossing that constricts the natural stream channel is considered undersized. The active channel width of the stream is larger than the width of the culvert and acts a funnel, creating faster flows. The increased velocity causes erosion at both the inlet and outlet. Undersized crossings are often accompanied by outlet drops and/or scour pools.



An example of an undersized crossing on Sawkill Road. Local ID: LEW\_004





### Outlet Drops/Perched Culverts

Outlet Drops or perched culverts occur when crossings are incorrectly installed/ designed and have large drops at the outlet. This situation can also be caused by erosion/scouring of the downstream stream bed.

An example of a culvert with an outlet drop on Atwood Road. Local ID: LEW\_031

### Shallow Crossings

Shallow crossings can create multiple risks for both flooding and aquatic life. They are usually either undersized or improperly aligned. This leads to high flows and erosion that causes low levels of flow inside the culverts. Shallow depths can become a barrier to fish passage and even become impassable or dry for extensive periods of time. They also may not have a substrate that matches the stream bed.



An example of a shallow crossing on Miron Lane. Local ID: LEW\_011



### **Clogged Crossings**

Clogged crossings create barriers to fish that make the crossing impassable. Specifically, clogged inlets can make it easier for upstream ponding and flooding to occur. If not removed, the backup of debris may also create an inlet drop. Crossings that are undersized or are known to have beaver activity are more at risk to become clogged.

An example of a clogged crossing.  
Local ID: SAW\_116

### **Ponding**

Ponding is the backup of water upstream of a crossing. Typically, this happens because a crossing is undersized and can continue throughout the year due to an issue like clogging or may occur seasonally due to an issue like highwaters/flooding. Ponding can create multiple problems. It may drive stream bank and road erosion and creation of wetland ecosystems. Ponding can also be harmful to aquatic life by

creating stagnant water, which leads to increased temperatures and lower oxygen levels.



An example of ponding. Local ID:  
LEW\_005





### Misaligned Crossings

Misaligned crossings are crossings that improperly installed in a way that causes the inlet to be skewed in relation to the stream. Crossings should be installed at the same angle as the stream. Crossings that are not have an increased chance of clogging, scouring or eroding, and ponding.

An example of a misaligned crossing on Atwood Road. Local ID: LEW\_901

### Scour and Erosion

Scour and erosion are consequences of all crossing insufficiencies besides shallow crossings. It is a direct consequence of high flow and ponding. Erosion of stream banks will occur both upstream and downstream of the crossing. Scour pools will occur at the downstream of perched crossings. This can lead to the undercutting of the crossing and possibly the road. Aquatic organisms are also affected as the natural substrate is eroded. This deteriorates passage and natural habitat.



An example of erosion caused by a crossing on Atwood Road. Local ID: LEW\_902



An example of a crossing that lacks natural substrate on Atwood Road. Local ID: LEW\_030

**Lack of Substrate**  
Natural substrate in a crossing that matches the stream is critical for aquatic organisms. By using the rocks as an anchor or a mechanism for movement by taking advantage of slower water around rocks and other substrate, aquatic organisms can safely maneuver through their environment. It is recommended that this idea is implemented within

a crossing to maintain natural conditions. Once natural conditions are maintained, stream continuity remains uninterrupted and scour is avoided. It's recommended that metal, or smooth and unnatural materials, be avoided

when constructing a culvert as these materials tend to increase water velocity.



An example of a crossing that is aging on Atwood Road. Local ID: LEW\_902

**Aging Infrastructure**  
It is recommended to replace crossings that are antiquated in terms of current crossing standards. Old crossings may have extensive scour and erosion. They may be failing or close to failing due to movement and/or breakage of individual components. These inefficiencies can pose a flood risk. A helpful suggestion is to keep and continually update records on infrastructure to allow for proper maintenance. Good maintenance can

protect a crossing against deterioration and prolong its life.

The scenarios discussed above are all examples of common impacts to streams. If not designed

and installed correctly, road-stream crossings can be very disruptive to aquatic organisms and the stream itself. These examples should be avoided if possible.



## 2.5 Dams

Dams are large barriers that stop or restrict the flow of water. They can be man-made or exist from nature (i.e. landslides or glacial deposition). Many dams are man-made structures and thousands of dams are in place across the United States. While dams can be useful to the public in many ways by suppressing floods and providing water; they can also pose a risk to the public if the structure fails, and they can be a threat to ecological integrity. Existing dams are getting older and new dams are being built in hazardous areas (NYSEDC 1987). The following sections below discuss the ways in which dams impact streams and aquatic organisms, as well as the potential circumstances that produce dam failure and how owners can protect against failures by doing proper maintenance:

### 2.5.1 Impacts to Streams and Aquatic Organisms

Dams change the way rivers and streams function, as well as having an effect on aquatic organisms. They can trap sediment, which bury rock riverbeds where fish spawn. Gravel, logs, and other important food and habitat features can also become trapped behind dams. This negatively affects the creation and maintenance of more complex natural habitats (e.g. riffles, pools) downstream.

Dams that divert water for power and other uses also remove water needed for healthy in-stream ecosystems. Peaking power operations can cause dramatic changes in reservoir water levels, leaving stretches below dams completely de-watered. This also can prevent fish migration by limiting their ability to access spawning habitat, seek out food resources, and escape predation. By altering the timing of flows by withholding and then releasing water to generate power for peak demand periods, natural seasonal flow variations are disrupted. Natural growth and reproduction cycles that occur in many species are destroyed.

Dams also slow rivers, which is another problem for aquatic organisms. They depend on steady flows to guide them, and become disoriented in stagnant reservoir pools, which oftentimes increased the duration of their migration. Dams also impact water quality by changing the temperature and oxygen levels of the water. For example, slow-moving reservoirs result in increased temperatures which affect sensitive species (American Rivers 2018).



### 2.5.2 Maintenance

The owner of a dam is responsible for maintaining and operating the dam in a safe condition at all times so it does not constitute a hazard to life, health, or property. A good maintenance program will protect a dam against deterioration and prolong its life.

Dam owners can do visual inspections on their own. It is recommended that dam owners inspect their dam at least once every three months and after significant storm events. It is important to keep records throughout the life of the dam as accurate records can help in the evaluation of the performance and condition of the structure over time. While inspecting the dam, the dam inspector should traverse the entirety of the structure. A few items to look for while inspecting the dam are as follows:

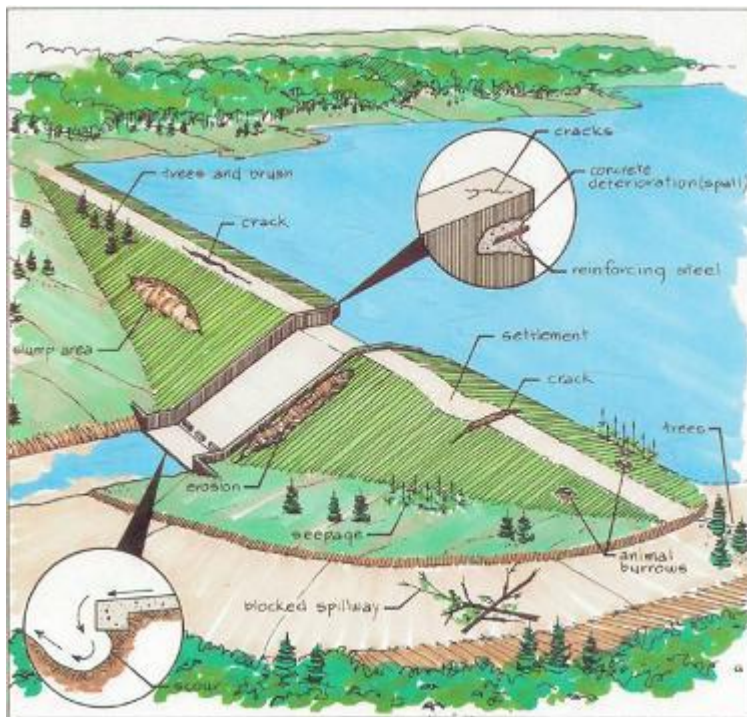

FIGURE 9: SIGNS OF DETERIORATION IN DAMS. GRAPHIC SOURCE: BRITISH COLUMBIA DAM SAFETY GUIDELINES.

settlement, turbid discharge, structural cracking, foundation movement, erosion, sinkholes, vandalism, animals burrows, boils, depressions, voids, debris in gates and spillways, wave erosion, excessive vegetation, seeps, and soil displacement on slopes (NYSDEC 1987)

Sometimes maintenance is immediately needed. According to the Owners Guidance Manual for the Inspection and Maintenance of Dams in New York State, the following conditions are critical and need immediate attention:

- A dam about to be overtopped or being overtopped
- A dam about to be breached (by progressive erosion, slope failure, or other circumstances)
- A dam showing signs of piping or internal erosion indicated by increasingly cloudy seepage or other symptoms
- A spillway being blocked or otherwise rendered inoperable, or having normal discharge restricted

- Evidence of excessive seepage appearing anywhere at the dam site (an embankment becoming saturated, seepage exiting on the downstream face of a dam) increasing in volume

An emergency action plan should be developed in advance and then activated when conditions like this occur. Usually a professional engineer is required to solve these types of situations. These are several other tasks that should be performed continually to keep the dam in good condition (NYSDEC 1987):

- Routine mowing
- Filling of any cracks and joints on concrete dams
- Observation of any springs or areas of seepage
- Inspection of dam (as discussed earlier)
- Monitoring of development in the watershed which would materially increase runoff from storms
- Monitoring of development downstream and updating the emergency notification plan to include new homes or other occupied structures within the area

### **2.5.3 Dam Failure**

Dam failure can be attributed to many complex reasons- both structural and non-structural. Sometimes the cause is directly tied to the design and construction process, as well as inadequate maintenance or operational mismanagement. Failures can also result from natural hazards. The following sections discuss dam failure caused by natural hazards and structural inadequacy as discussed by NYSDEC in the Owners Guidance Manual for the Inspection and Maintenance of Dams in New York State:

#### **Natural Hazards**

There are several different types of natural hazards that may cause dam failure, including:

- Flooding from high precipitation
- Flooding from dam failure
- Earthquakes
- Landslides

Floods are the most pertinent natural hazard in the northeastern United States. Flood-plain areas are more prone to flooding and should be included in the risk assessment for dam failure. When a dam receives a sudden surge of water caused by a natural flood, it will usually exceed the maximum flood expected naturally. This can

put the dam at risk for failure. People and property are more at risk during a flood caused by dam failure than a natural flood. Loss of life and damage almost always increases (NYSDEC 1987)

### **Structural Failure**

The three categories of structural failure are discussed below.

- **Overtopping by Flood:** Overtopping may develop from many sources, but often evolves from inadequate spillway design. Possibly even an adequate spillway may become clogged with debris. In either case, water pours over other parts of the dam, such as abutments or the dam toe and erosion and failure follow. Once erosion has begun during overtopping, it is extremely difficult to stop (NYSDEC 1987). Overtopping accounted for 70.9% of all dam failures in the United States from 1975-2011 (FEMA 2013)
- **Foundation Defects:** Foundation defects can occur for multiple reasons. It could be due to inadequate initial design, failure to assess the regional geology properly, poor construction, or gradual degradation and weakening over time. Foundations may be weakened internally as well due to internal piping or internal erosion. Concrete dams are most susceptible to foundation failure and can occur with the loss of the entire concrete dam structure. Typical warning signs include cracking and settlement (FEMA 2013).
- **Piping:** Piping is internal erosion of an earth dam that takes place when water seeps through the dam and carries soil particles away from the embankment, filters, drains, foundation or abutments of the dam. Piping can lead to a complete failure of the structure. Signs of piping include an increased seepage flow rate, the discharge of muddy or discolored water below the dam, sinkholes on or near the embankment, and a whirlpool in the reservoir. Earth dams mainly suffer from seepage and piping. Piping accounted for 14.3% of all dam failures in the United States from 1975-2011(FEMA 2013).

Failure also depends on the type of dam. Gravity dams are the safest, followed by arch and fill dams. Buttress dams are the most unsafe (NYSDEC 1987).

## Section 3: Best Management Practices

Best  
Management  
Practices

---

### 3.1 General Recommendations

---

### 3.2 Installing and Replacing Culverts

---

Section 3 describes the best current management practices for road-stream crossings. First, general recommendations are presented. Recommendations on building road-stream crossings that allow for natural stream function and implementing green infrastructure are provided. An overview of the Climate Smart Communities Program and how municipalities can get involved is presented. The last subsection delves into more specific information on how to install and replace road-stream crossings. Guidelines from New York State Department of Environmental Conservation are presented, as well as Stream Simulation Design instructions.

## 3.1 General Recommendations

### 3.1.1 Build Road-Stream Crossings that Allow for Natural Stream Function

Road-stream crossings that are designed to conserve stream shape and processes accomplish multiple benefits- these structures reduce long-term maintenance costs, risk of failure during large floods, and restore stream habitat connectivity (Forest Service Stream-Simulation Working Group 2008). Flood risk and habitat barriers at non-bridge road-stream crossings are often seen together. Minimum intervention in the stream process results in the least risk for both flooding and affecting aquatic organisms negatively, as the crossing can accommodate a large range of flood discharges and sediment/debris inputs without compromising aquatic organism passage. It's a simple approach and often saves communities in the long-term. Whenever possible, build road-stream crossings that allow for natural stream function upstream, downstream and within the structure.

### 3.1.2 Keep Up to Date With the Latest Hydrologic Data

Climate change has created a greater likelihood of intense rainfall and extreme precipitation events in northeastern U.S. towns. It is likely that many structures were designed with historical hydrologic data and are more susceptible to flood risk. This trend is expected to continue as climate change progresses, which makes it imperative that hydrologic data for future storms are incorporated when designing road-stream crossings.

### 3.1.3 Track Maintenance and Replacement Projects

Any inventory or maintenance records should be updated regularly to reflect changing stream and structure conditions as well as ongoing maintenance and replacement projects. This is important for internal record-keeping and continuation of knowledge between staff. It is also extremely helpful for securing financing for replacement projects.

### 3.1.4 Consider Implementing Green Infrastructure Upstream of Undersized Structures

Heavily developed areas often have poor stormwater drainage due to large amounts of impervious surfaces. Impervious surfaces, like roofs, roads and parking lots, prevent runoff from soaking into the ground as it would in undeveloped areas. Instead, runoff is more likely to drain into a stream channel. This results in higher peak flows, which puts more strain on road-stream crossings that are undersized and increases flood risk. Green Infrastructure can help capture and infiltrate stormwater runoff before it reaches the stream channel, which helps reduce flood risk for inadequate road-stream crossings.



FIGURE 10: CHANGES IN PROPORTION OF RAINFALL THAT BECOMES RUNOFF IN DIFFERENT IC SCENARIOS.

### 3.1.5 Climate Smart Communities Program

**Background:** The Climate Smart Communities (CSC) Program began in 2009 as an interagency initiative of New York State. The CSC Program is jointly sponsored by the following six New York State agencies: Department of Environmental Conservation (DEC); Energy Research and Development Authority (NYSERDA); Department of Public Service; Department of State; Department of Transportation; Department of Health and the Power Authority (NYPA). DEC administers the program.

The goals of the CSC Program are to engage and educate local governments in New York State, provide a robust framework to guide their climate action efforts, and recognize their achievements as they make progress. Participation in the program is voluntary and is designed to encourage ongoing planning and implementation of actions that reduce of greenhouse gas emissions and help communities adapt to the effects of climate change.

**CSC certification:** CSC certification represents the next step in the evolution of the program and provides specific guidance on how to implement the CSC Pledge, adoption of which is the first step to participation in the CSC Program. In order achieve CSC certification, a municipality must go beyond adoption of the CSC Pledge

by completing and documenting a suite of actions that mitigate and adapt to climate change at the local level. The CSC certification program recognizes communities for their accomplishments through a rating system leading to three levels of award: bronze, silver, and gold.

There are over 120 CSC actions available for municipalities under the program, with detailed information, resources, and examples available for each. The actions are organized under the Pledge Elements outlined in the CSC Pledge, and applicants can earn additional points by demonstrating innovation or high levels of performance under the “Innovation” and “Performance” categories:

### **CSC Pledge Elements**

1. Build a climate-smart community.
2. Inventory emissions, set goals, and plan for climate action.
3. Decrease energy use.
4. Shift to clean, renewable energy.
5. Use climate-smart materials management
6. Implement climate-smart land use.
7. Enhance Community Resilience to Climate Change.
8. Support a green innovation economy.
9. Inform and inspire the public.
10. Engage in an evolving process of climate action.
11. Innovation
12. Performance

**CSC Portal:** As participation in the CSC Program has grown since its inception, the web-based CSC Portal (<https://climatesmart.ny.gov/>) increasingly serves as a resource for municipalities seeking information and guidance on the hundreds of CSC actions available to them, as well as a repository of the documentation submitted by each community achieving CSC certification. The full Certification Reports for all certified CSCs can be filtered by individual municipality, or by specific CSC actions in the “Participating Communities” section of the Portal.

### **Local CSC Engagement**

**Ulster County:** Ulster County was the first County to achieve Silver-level CSC certification in 2016, a notable achievement, and the CSC Program serves as a framework for the County’s climate action initiatives. The County continues to work towards implementing more of the identified actions in the CSC Program and has used the Program in part to guide actions identified and prioritized in the roadmap section of the Ulster County Government Operations Climate Action Plan (2019).

The County will be applying for its first five-year Silver-level CSC recertification in 2021. The County Road-Stream Crossing Management Plan developed as part of this NEIWPCC-funded project will be included in the County's CSC recertification application under the *PE7 Action: Culverts and Dams* (updated November 2020), as will relevant implementation projects.

Points for this action are tiered based on completion of the components described below. All must have occurred within ten years prior to the application date.

- Conduct an assessment of all road-stream crossings that fall under the responsibility of the local government using the NAACC protocol (2 points)
- Develop a road-stream crossing municipal management plan that prioritizes crossings for replacement based on threats to flooding and aquatic connectivity (2 points)
- Right-size at least one culvert or bridge. It must not be a barrier to aquatic connectivity and must be sized to future climate projections (e.g., to the standards recommended in the Draft NYS Flood Risk Management Guidance). A maximum of 12 points is available for 2 (or more) right-sizing projects (6 points per project)
- Conduct a dam inventory (2 points)
- Remove one or more dams identified as barriers to aquatic connectivity and/or are in hazardous condition (6 points)

Future culvert and bridge upgrades or replacements and dam removals could also be documented for additional points under the implementation component of the action outlined above.

Additionally, the local Road-Stream Crossing Management Plans developed as part of this project in collaboration with the Towns of Kingston, Saugerties, and Woodstock could potentially be used by each Town towards their individual CSC certification (or recertification) documentation, as could relevant local implementation projects.

**Local Municipalities:** In addition to the County's active participation in the CSC Program, there is significant engagement by local municipalities within the County. The Town of Saugerties passed the CSC Pledge in 2010, achieving bronze-level CSC certification in March 2020, and Town of Woodstock passed the CSC Pledge in 2016, achieving bronze-level CSC certification in September 2020.

These are among many local municipalities with varying levels of participation, with some considering adoption of the CSC Pledge as a first step, others with actively engaged CSC Task Forces, and some having also achieved CSC certification. These



include the City of Kingston, which achieved its five-year Silver-level recertification in 2020, and the Town and Village of New Paltz and the Town of Marbletown, which all achieved bronze-level CSC certification in 2020. The County Department of the Environment maintains a webpage which provides updated information on both the County and local CSC Program participation and available resources (<https://ulstercountyny.gov/environment/climate-smart>).

### 3.1.6 Flood Risk

In August 2020, New York finalized its [State Flood Risk Management Guidance \(SFRMG\)](#). This guidance was developed as an outcome of the [2014 Community Risk and Resiliency Act \(CRRRA\)](#), which tasked numerous State departments and programs to enhance resilience across New York to rising sea levels and extreme flooding in the future.

Although this guidance did not establish any legally binding standards for structures or permitting of, it provided recommendations to agencies and municipalities to consider predicted future flows and flood levels for future projects. NYSDEC and other state agencies that may provide funding for or permitting of structures (such as culverts) are now expected to consult the SFRMG as they consider applications. This new requirement now ensures that applicants, such as municipalities, have demonstrated at least a consideration of sea-level rise and future flows/flooding in their application.

The SFRMG acknowledges the importance of culverts, for example, as an integral part of communities, and the State as a whole, in becoming more resilient to our changing climate. In alignment with the 2016 NYSDOT Design Manual, the SFRMG recommends that a design future/flow multiplier of 120% be added to the current design flow in our region of the State for any culvert with an end of life design between 2025-2100. Further, the SFRMG recommends that transportation infrastructure, such as culverts, bridges, and even roadways, be defined as either “critical” or “non-critical” depending upon its importance during a flood event. As you might expect, the more critical the piece of infrastructure is, the higher (more protective) the recommended design standard should be. For example, the design flow for “critical” culvert should either be the 0.2% annual chance flood (Q500), or the current design flow (such as Q50) plus the future flow multiplier, whichever is greater.

The SFRMG document also makes it clear that site conditions, natural resources, size/scale, adjacent lands uses, and other factors often complicate project design and construction. Therefore, application of the highest flood-risk management guideline is not warranted or practical in all cases. Design flow elevations or capacities that municipalities incorporate into design and risk-assessment protocols

should include other relevant factors, such as feasibility, project cost, costs of flooding, funding eligibility, risk tolerance, environmental effects, and historic preservation.

## 3.2 Installing and Replacing Culverts

The next few sections discuss how to design and construct road-stream crossings without altering natural stream channel.

### 3.2.1 New York Stream Crossing Guidelines

The following recommended standards are the current New York Stream Crossing Guidelines (developed by the New York State Department of Environmental Conservation). This guideline is provided on the NYSDEC website and is effective for reducing stream barriers and impediments to fish and wildlife.

The following recommendations are to assist in designing, installing, and replacing stream crossing structures in small streams, with the goal of protecting stream continuity. Pre-installation stream conditions should be retained to the maximum extent possible. Structures should be designed and installed so that the natural stream flow and bottom substrate are mimicked throughout the crossing and so that the structure does not constrict or fragment the stream. Additional engineering design may be necessary to ensure structural integrity and appropriate hydraulic capacity.

#### Types of Crossings:

Bridges and open bottom box culverts are the preferred crossing method. Other methods, in descending order of preference, include open-bottom arch culverts (typically installed on concrete footings), box culverts (typically pre-cast concrete), arch or elliptical/squash culverts (metal, concrete, or plastic), and circular culverts (metal, concrete, or plastic).

The structure should be located within a stretch of watercourse where the channel is straight, unobstructed, and well defined. When selecting a crossing location, choose a

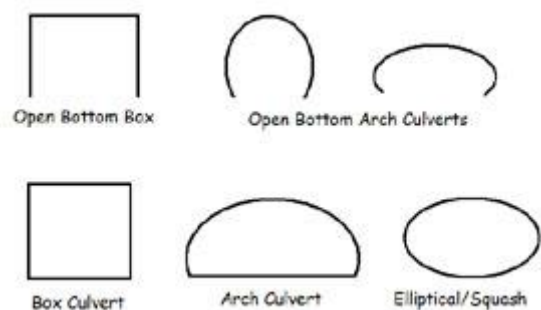

FIGURE 11: DIFFERENT TYPES OF CROSSINGS.

straight, flat area where the streambed/bank characteristics can be easily retained or replicated, and erosion potential can be minimized. Areas where wetlands exist along the stream should be avoided when possible.

**Length and Side Slopes:**

Road and shoulder widths should be the minimum necessary for the crossing and side slopes should be as steep as possible without compromising stability to minimize the length of the culvert. Note: A side slope grade of 2:1 is typically the steepest grade that can be vegetated.

**Capacity/Size:**

The width of the structure should be 1.25 times the normal (Figure 12 and 13) width of the streambed. The overall culvert capacity should be able to accommodate expected high flows.

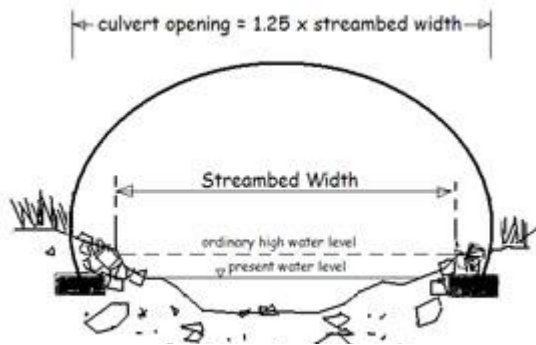

FIGURE 12: GRAPHIC SOURCE: NYSDEC

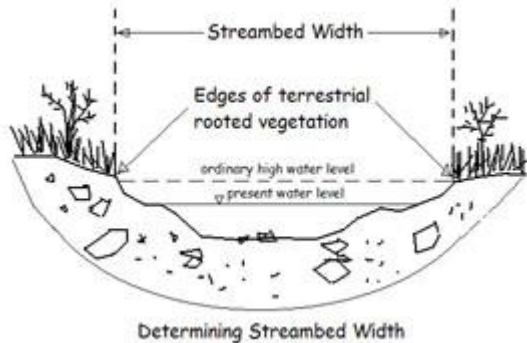

FIGURE 13: GRAPHIC SOURCE: NYSDEC

**Installation**

For "closed-bottom" culverts, the streambed slope must be less than 3% (3-foot vertical rise in 100 feet of channel length), and the culvert installed level with at least 20% of the vertical rise embedded at the downstream invert.

Culvert installation should take place "in the dry", to facilitate construction and reduce downstream impacts from turbidity and sedimentation. This may require piping or pumping the stream flow around the work area and the use of cofferdams. The duration of dewatering should be kept to a minimum and flows immediately downstream of the worksite should equal flows immediately upstream of the worksite.

**Erosion Control:**

Rip rap should be used as head wall protection to prevent scouring around the inlet and outlet of the culvert. High flows can erode the soil surrounding the inlet and the soil underneath the outlet of a culvert. Both instances can cause culvert undermining and can adversely affect the structural integrity of the road crossing.

Appropriate erosion and sediment controls, including silt fencing, should be installed parallel to the stream to prevent downstream impacts and should be depicted on project plans.

Disturbance of the streambed and banks should be limited to that necessary to place the culvert. Effected bank and bed areas should be restored to pre-project conditions following installation of the culvert and the banks should be planted with native vegetation, consistent with that which existed prior to the culvert installation.

Seeded banks should be covered with mulch to accelerate plant growth.

**Timing:**

To protect fish spawning, timing restrictions may be imposed for all instream work as well as any adjacent work that may result in suspension of sediment in a stream. In general, instream work should occur during low flow conditions, typically between June and September, to minimize impacts to fisheries and water quality. For additional information on timing restrictions, please contact the regional NYSDEC office (Region 3 for this project area).

**Maintenance:**

It is recommended that stream crossing structures be maintained at least once annually, preferably before high spring flows. Typical maintenance includes checking for structural deficiencies such as undermining and debris buildup.

**NYSDEC Permits**

Permits are required for streams classified as C(T) or higher quality (ECL Article 15-0501), navigable bodies of water (ECL Article 15-0505), and NYSDEC regulated wetlands (ECL Article 24). For additional information, please contact the regional NYSDEC office.

Ulster County NYSDEC (Region 3) contact information:

- Fax: 845-255-4659

- E-mail: [dep.r3@dec.ny.gov](mailto:dep.r3@dec.ny.gov)

Ulster County Regional Permit Administrator:

John Petronella

NYSDEC

21 South Putt Corners Rd.

New Paltz, NY 12561-1620

845- 256-3054

**Permits may also be required from other agencies, such as**

U.S. Army Corps of Engineers

FEMA: No Rise Certifications

### **3.2.2 Green Stormwater Infrastructure**

Another way to reduce flood-risk is to invest in green stormwater infrastructure. Green stormwater infrastructure diminishes harmful stormwater runoff. Stormwater runoff is a major cause of water pollution due to the large amount of manmade structures that block rain from soaking into the ground as it should. As well as being harmful by carrying trash, bacteria, heavy metals, and other pollutants into the landscape, higher flows resulting from heavy rains can cause erosion and flooding in urban streams, damaging habitat, property, and infrastructure. It can protect from costly damage that may occur from flooding. In areas that are undeveloped, the water is absorbed and filtered by soil and plants and thus stormwater runoff is cleaner and less of a problem. Green stormwater infrastructure uses vegetation, soil, and other practices to restore the environment. Green infrastructure can include rain gardens, rooftop disconnects, bioretention areas and basins, vegetated swale, pervious surfaces, rain cisterns and green roofs. This type of infrastructure will be most effective in areas that are heavily developed and have a large number of road-stream crossings. By funding green infrastructure projects, money will be saved in the way of damaged crossings, infrastructure and personal injury that could all result from a failed and/or flooded road-stream crossing (NYSDEC 2020).

## Section 4: Culvert Prioritization

Culvert  
Prioritization

---

### 4.1 How to Use Data

---

### 4.2 Navigating the Scoring

---

### 4.3 Multi-Jurisdictional Hazard Mitigation Plan Projects

---

### 4.4 County-Owned Bridges

---

### 4.5 Unscored Metrics

---

#### Culvert

Prioritization presents information specific to Ulster County. The first section details how to access and use the data presented in an excel spreadsheet. Within that section, subsections present detailed statistics on the worst rated road-stream crossings found. Worst rated MOSCAP and DOT road-stream crossings are provided, as well as the road-stream crossings that have the highest flood risk based on the Cornell Culverts Model. A cross-reference between the Multi-Jurisdictional Hazard Mitigation Plan and the road-stream crossings assessed in this project and a section detailing the institutional knowledge from Ulster County are the last sections provided. The detailed analysis in Culvert Prioritization is essential to build a community to be more resilience to flood-risk.

## 4.1 How to Use Data

### 4.1.1 Local ID & Survey ID

Each road-stream crossing has a survey ID and local ID attached to it. Either one can be used to look up a crossing on the excel spreadsheet.

An important note: Each road-stream crossing has an additional ID labeled “Culvert\_ID”. The culvert ID cannot be used to look up the crossing. This is *not* to be confused with the survey ID or local ID.

#### Survey ID

The survey ID is a numeric label automatically assigned to each crossing when uploaded to the NAACC database. It is NAACC specific and can be used to look up the road-stream crossing on the NAACC website. A link to website can be found here: [https://naacc.org/naacc\\_search\\_crossing.cfm](https://naacc.org/naacc_search_crossing.cfm)

Once on the NAACC website, click “Search Crossings” located near the upper left corner.

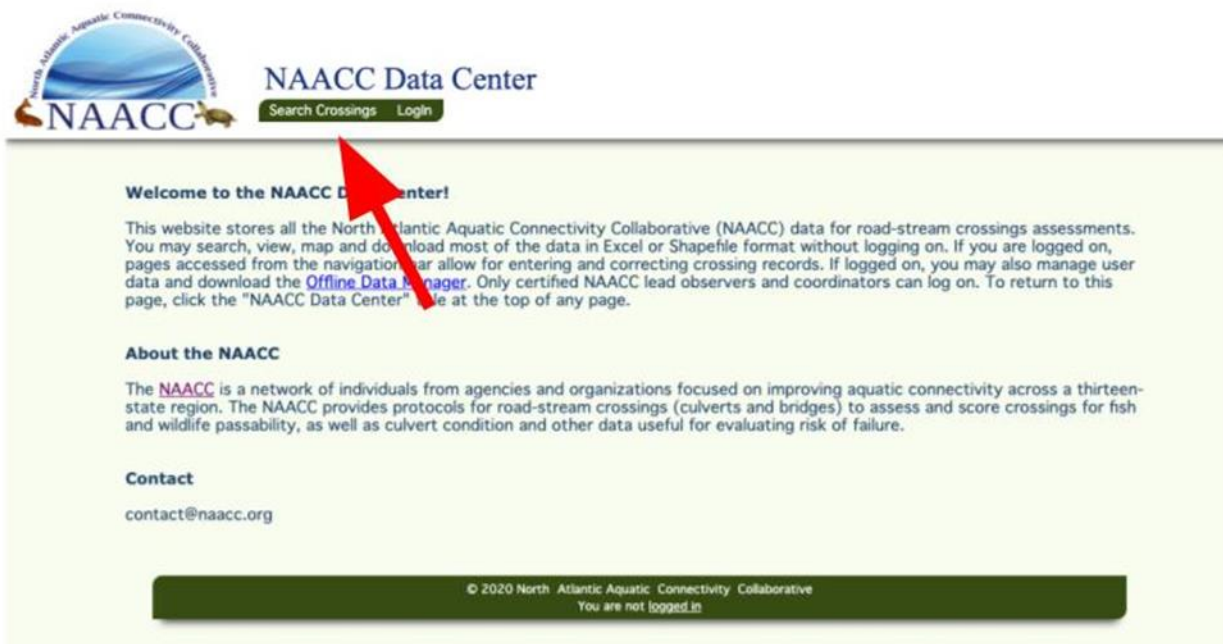

**NAACC** North Atlantic Aquatic Connectivity Collaborative

**NAACC Data Center**

Search Crossings Login

**Welcome to the NAACC Data Center!**

This website stores all the North Atlantic Aquatic Connectivity Collaborative (NAACC) data for road-stream crossings assessments. You may search, view, map and download most of the data in Excel or Shapefile format without logging on. If you are logged on, pages accessed from the navigation bar allow for entering and correcting crossing records. If logged on, you may also manage user data and download the [Offline Data Manager](#). Only certified NAACC lead observers and coordinators can log on. To return to this page, click the "NAACC Data Center" link at the top of any page.

**About the NAACC**

The **NAACC** is a network of individuals from agencies and organizations focused on improving aquatic connectivity across a thirteen-state region. The NAACC provides protocols for road-stream crossings (culverts and bridges) to assess and score crossings for fish and wildlife passability, as well as culvert condition and other data useful for evaluating risk of failure.

**Contact**

contact@naacc.org

© 2020 North Atlantic Aquatic Connectivity Collaborative  
You are not logged in

On the search page there are multiple filter options. To find a specific culvert, enter the survey ID in the “Other: Survey ID” search bar.

The search interface includes the following elements:

- Location (choose multiple towns, watersheds):** A dropdown menu set to "All States [56511]".
- Other:** A text input field for "Survey ID" which is circled in red.
- Crossing Code:** An empty text input field.
- Personnel:** Two dropdown menus for "Any Observer" and "Any Coordinator".
- Choose Data Sets (choose multiple):** A list of data sets including "Non-tidal Connectivity Assessments", "NAACC (after 6/1/2015)", "UMass Stream Continuity Project (2005-2013)", "Connecticut (2004-2013)", "Vermont (11/20/2002-10/29/2015)", "Maine (2007-2015)", and "New Hampshire (2006 - 2016)".
- Dates:** Four date range filters for "Date observed", "Last updated", and "Date observed until", each with an "All" button.
- 25 per page:** A dropdown menu.
- Search:** A button in the bottom right corner.

The results will be displayed at the bottom of the page.

The search results page displays the following components:

- Filters:** A partial view of the search filters from the previous screenshot, including "Appomattox", "Personnel", "25 per page", and "Choose Data Sets".
- Map With Google Maps:** A button to view the results on a map.
- Data Set Summary Table:**

Data Set	GIS	Excel Reports		
NAACC (after 6/1/2015)	<a href="#">shapefile</a>	<a href="#">simple</a>	<a href="#">detailed</a>	Not available
- Showing 1 Records:** A table with one record. The "Crossing Code" field is circled in red.
 

Survey ID	Crossing Code	Date Observed	Last Updated	Town	Stream	Road	Evaluation	Culvert
7630	rs21172917657219	2020/07/13	2020/07/13	Saugerties NY	No data	W saugerties rd	no score - missing data	1
- Footer:** © 2020 North Atlantic Aquatic Connectivity Collaborative



Clicking the crossing code will open a page containing data collected in the field.

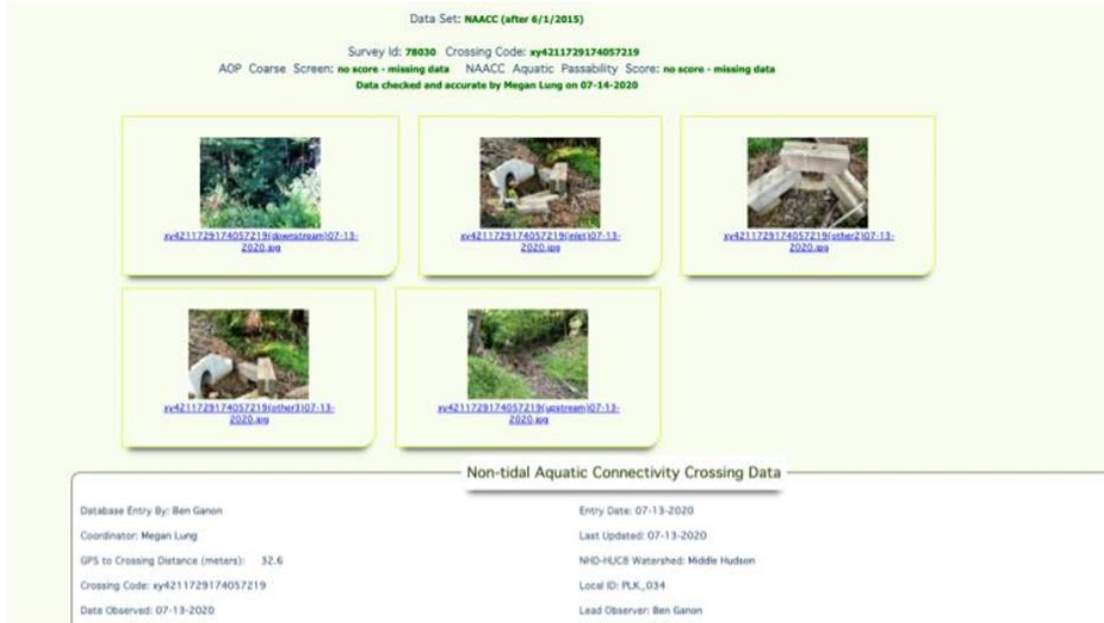

## Local ID

The local ID was assigned to each road-stream crossing depending on the watershed it's located in during GIS desktop analysis. It contains an abbreviation of the watershed followed by a numeric value ( i.e. ABC\_###). The local ID's can be used to identify crossings on the physical maps or on the excel spreadsheet. It cannot be used to look up a road-stream crossing on the NAACC database. A key for each abbreviation is provided below.

In the maps provided with the inventory, the RSX are labeled with the local ID. Also included on the maps are the Ulster County Habitat Cores in order to visually assess habitat reconnection potential. For more information, see: <http://www.gicinc.org/PDFs/GIC%20NY-Practitioners%20Guide-Chapter%205-reduced.pdf>.

### Key

BVK = Beaverkill Watershed  
ESG = Eastern Saugerties  
LBV = Lower Beaverkill Watershed  
LEW = Lower Esopus Watershed  
PLK = Plattekill Watershed  
SAW = Sawkill Watershed

## 4.2 Navigating the Scoring

### 4.2.1 MOSCAP

In the inventory provided, MOSCAP score is calculated using the geomorphic (gc), structural, flood, and Aquatic Organism Passibility (AOP) component. The weighted scoring originated from the Ashokan Watersehd Stream Management Program in consultation with the Ashokan Highway Managers Working Group. The weighted scores are as follows:

- Flood Component = 30%
- Geomorphic Component = 30%
- Structural Component = 30%
- AOP Component = 10%

### 4.2.2 DOT

DOT scoring only looks at the culvert and the road. The DOT section of the survey includes rapid visual inspections of the span barrel, headwalls/wingwalls, abutment, embankment, road, and settlement. They are inspected objectively and consistently. These scores should be used in conjunction with, not in replacement of, engineering data.

The DOT Score is a numeric DOT Structural Condition Score. Each crossing is given a score between -100 and +100. The lowest ranking score is -100 and the highest is +100. The DOT screen assigns a categorical assessment of the structural condition (Good, Fair, Poor, Bad) based on the numeric DOT score. To see the worst DOT scored crossings in the Town of Kingston, sort by DOT score.

### 4.2.3 NAACC

AOP stands for Aquatic Organism Passage. The AOP Score is calculated for each crossing using numerous variables within the NAACC survey, like constriction and outlet drop, that are observed in the field. A categorical assessment (titled 'Evaluation') is assigned to the numeric AOP Score (No Barrier, Insignificant Barrier, Minor Barrier, Moderate Barrier, Significant Barrier, and Severe Barrier). The lower the AOP Score, the more severe the crossing is as a barrier to aquatic organisms. To see the worst AOP scored crossings in the Town of Kingston, sort by AOP score.

### 4.2.4 Geomorph

GC score stands for geomorphic compatibility score. There are five GC scores: 20, 40, 60, 80, 100. The lower the score, the less compatibility the road-stream crossing has with the stream. To see the worst geomorph scored crossings in the Town of Kingston, sort by GC score.

#### 4.2.5 Highest Flood Risk (The Cornell Culverts Model)

The Cornell Culverts Model helps identify undersized culverts for both current and future precipitation estimates. Point data, structure dimensions and DEM are used to calculate capacity of the structure. The model predicts current and future peak flows in location of the crossing and then compares it to the capacity of the culvert. This then determines what size storm the structure can pass. This data can be used to help identify culvert replacement projects, but should not be used in replacement of an engineering assessment. For more information, please visit:

<https://wri.cals.cornell.edu/hudson-river-estuary/watershed-management/aquatic-connectivity-and-barrier-removal-culvert-dams/culverts/>

### 4.3 Multi-Jurisdictional Hazard Mitigation Plan Projects

Hazard mitigation plans help develop long term strategies for protecting people and property from future events. Sometimes road-stream crossing work is included in these plans. The following section lists the hazard mitigation plan projects that overlap with the road-stream crossings assessed in this project. The current Ulster County hazard mitigation plan can found through the following link:

<https://ulstercountyny.gov/emergency-services/hazard-mitigation>

#### Town of Kingston

Project Name	Location	Local ID	Survey ID	NAACC Score	MOSCAP Score
Community Action #1	Sawkill Road near Ballpark Road	SAW_183	78410	Insignificant barrier	Low

#### Town of Woodstock

Project Name	Location	Local ID	Survey ID	NAACC Score	MOSCAP Score
Woodstock	Mink Hollow	BVK_45	63780	Insignificant	High

#1	Bridge			barrier	
Woodstock #4	Wittenberg/ Shultis Farm Road	LBV_20	64276	Minor barrier	High
Woodstock #6	Bellows Lane	SAW_084	77162	Insignificant barrier	High
Woodstock #7	Zena-Sawkill Road	SAW_151	77640	Severe barrier	High
Woodstock #9	Glenford- Wittenberg Road	LBV_34	64273	Minor barrier	Medium
Woodstock #20	Ideal Park Road	BVK_72	63885	Insignificant barrier	Medium
Woodstock #21	Mink Hollow Bridge	BVK_45	63780	Insignificant barrier	High

### Town of Saugerties

Project Name	Location	Local ID	Survey ID	NAACC Score	MOSCAP Score
Saugerties #4	Wilhelm Road	ESG_008, ESG_010	78339, 78371	Minor barrier, Severe barrier	Medium, High
Saugerties #5	Cottontail Road	PLK_105	78200	Moderate barrier	Low
Saugerties #6	Platteclove Road	PLK_034	78030	No score- missing data: Downstream not accessible due to steep topography	Medium

Saugerties #7	Van Vlierden Road	PLK_025	78346	Moderate barrier	Low
---------------	-------------------	---------	-------	------------------	-----

## 4.4 County Owned Bridges

In the Lower Esopus Watershed there are 21 County owned bridges as noted in the charts below.

### Town of Saugerties

BIN	Bridge Name	Town	Feature Carried	Feature Crossed	Span	Year Built	Local ID	NAACC ID
3346570	MT MARION	Saugerties	COUNTY ROAD 31	PLATTEKILL CREEK	123'-0"	1994	PLK_132	79259
3346740	MYER	Saugerties	COUNTY ROAD 35	PLATTEKILL CREEK	48'-0"	1993	PLK_053	78719
3346750	STONE ARCH	Saugerties	COUNTY ROAD 33	PLATTEKILL CREEK	64'-0"	1995	PLK_039	78052
3346810	JESSE WOLVEN	Saugerties	BLUE MOUNTAIN RD	PLATTEKILL CREEK	50'-0"	1995	PLK_026	78024
3346820	CEMETERY	Saugerties	BLUE MOUNTAIN RD	LUCAS KILL	50'-0"	1996	PLK_012	77933
3346850	SAUER	Saugerties	GLASCO TURNPIKE	ESOPUS CREEK	85' & 119'	1962	PLK_121	79255
3346910	CONYES	Saugerties	SNYDER ROAD	PLATTEKILL CREEK	2 @ 41'-0"	2001	PLK_150	79446
3347030	SAWKILL	Saugerties	MALDEN TURNPIKE	SAWYER KILL	30'-0"	1988	ESG_041	78844
3347270	DALY	Saugerties	MILLARD BURNETT R	PLATTEKILL CREEK	60'-0"	2001	PLK_040	78033

3347280	BECKER	Saugerties	BECKER ROAD	PLATTEKILL CREEK	25'-6"	1996	PLK_037	78031
3347690	BERT LAW	Saugerties	COUNTY ROAD 32	PLATTEKILL CREEK	90'-0"	1969	PLK_119	76966
3347750	FISHCREEK	Saugerties	FISH CREEK ROAD	PLATTEKILL CREEK	92'-0"	1965	PLK_095	78268
3347790	SAUGERTIES RESERVOIR	Saugerties	CLRK VANVLERD N RD	PLATTEKILL CREEK	56'-0"	1966	PLK_041	78717
3346510	WOLVEN	Woodstock	COUNTY ROAD 30	SAW KILL	52'-0"	1995	SAW_118	77020
3347290	MUNDY	Woodstock	TANNERY BROOK RD	TANNERY BROOK	45'-0"	1997	SAW_110	77166
3347330	BOOTH	Woodstock	MELLERT ROAD	SAW KILL	56'-0"	1981	SAW_136	77639
3347710	SULLY	Woodstock	TANNERY BROOK RD	SAW KILL	58'-0"	1998	SAW_121	77167
3347820	KINGSTON RESERVOIR	Woodstock	ZENA HIGHWOODS RD	SAW KILL	94'-0"	1968	SAW_168	77645
3224810	JOHN JOY	Woodstock	JOY ROAD	SAW KILL	91'-0"	1975	SAW_165	77643
3347500	SAWKILL CHURCH	Kingston	COUNTY ROAD 30	SAW KILL	90'-0"	1987	SAW_192	78532
3347860	POWDERMILL	Kingston	POWDERMILL ROAD	SAW KILL	90'-0"	1970	SAW_185	78529

## 4.5 Unscored Metrics

Some road-stream crossings are not able to be scored because the data contains missing metrics and the calculations to find the final score cannot be completed. Common missing metrics are:

- Active Channel Width
- Downstream Metrics, like the outlet measurements

These metrics are not measured in the field for several reasons:



- The RSX is on private property
- The topography is inaccessible on either the inlet or outlet
- The stream is buried
- The RSX is a bridge and is determined to be bridge adequate (meaning the bridge is new and passes the stream in its entirety)

Below is a chart of the RSX crossings in the Town of Saugerties that are missing a metric, as well as the reason why.

Local ID	Survey ID	Missing Metric	Reason	Road	Town
LEW_005	76987	Active Channel Width	No upstream channel - wetland	Rt 28a	Hurley
LEW_019	77939	Active Channel and DS armoring, erosion, scour, banks higher than, culvert slope	Buried Stream	Hurley Ave	Hurley
LEW_022	77942	Active Channel Width	Bridge Adequate	Wynkoop Rd	Hurley
LEW_050	77950	Active Channel Width	Crossing comments in NAACC state “unable to measure active channel because upstream is a pond”	Hurley Mountain Rd	Marbletown
LEW_053	77947	Active Channel Width	Bridge Adequate	Hurley Mountain Rd	Marbletown
LEW_043	76919	Multiple Metrics	Not_Applicable in MOSCAP, note in NAACC says “No culvert”	Atwood Rd	Marbletown
LEW_054	76922	Span barrel Rating	Partially inaccessible, could not see span barrel to give it a rating	Atwood Rd	Marbletown

LEW_035	77807	Active Channel Width	No upstream channel, crossing comments in NAACC state “stream may have moved no us channel”	Atwood Rd	Marbletown
LEW_038	77809	Active Channel Width	Not stated in NAACC, but photos show upstream channel is buried	Krumville Rd	Olive
PLK_132	79259	Active Channel Width	Channel was too deep to be able to get active channel	Old Kings Hwy	Ulster
PLK_137	79048	Active Channel Width	Bridge Adequate	Leggs Mills Rd	Ulster
PLK_034	78030	Several DS metrics	DS not accessible due to topography	W Saugerties Rd	Saugerties
PLK_041	78717	Missing Active Channel	Partially Inaccessible, dam leading from reservoir	Reservoir Rd	Saugerties
PLK_088	78266	Downstream metrics	Structure comments in NAACC state “estimated outlet measurements and length due to inaccessibility”	Fish Creek Rd	
PLK_120	79448	Multiple Metrics	Inaccessible, note in NAACC states “Inaccessible due to a ridiculous amount of poison ivy on inlet and fence at outlet”	Glasco Tpk	Saugerties
PLK_121	79255	Active Channel Width and some NAACC measurements	Bridge Adequate	Glasco Tpk	Saugerties
PLK_032	78028	Multiple Metrics	Inaccessible, note in NAACC states “Inlet not accessible due to wall. Outlet not accessible due to poison ivy”	Blue Mountain Rd	Saugerties

PLK_113	78199	Active Channel Width	Crossing comments in NAACC states “unable to get active channel because of barbed wire fencing. Upstream mostly marsh”	Glasco Tpk	Woodstock
SAW_077	77123	Active Channel Width	Note in NAACC stating” No visible active channel dry stream with vegetation”	Glasco Tpk	Woodstock
SAW_116	76850	Active Channel Width	No upstream channel - wetland	Wittenberg Rd	Woodstock
SAW_121	77167	Active Channel Width	No photo of US channel in NAACC, but inlet photo shows buried upstream channel	Tannery Brook Rd	Woodstock
SAW_169	77646	Active Channel Width	Note in NAACC states “upstream is a man made pond with fountain in middle, unable to get active channel”	Sawkill Rd	Woodstock

---

## 5.1 Federal Funding

---

## 5.2 State Funding

---

## 5.3 Local Funding

---

**This project identifies road-stream crossings that negatively impact aquatic passibility, are structurally in poor condition, and are a flood risk. The following section details funding opportunities to replace or maintain road-stream crossings.**



## 5.1 Federal Funding

### FEMA Hazard Mitigation Assistance Grants

FEMA Hazard Mitigation Grants assists in implementing long-term hazard mitigation planning and projects to reduce or even eliminate long-term risk to people and property from future disasters. It provides funding for eligible mitigation measures that reduce disaster losses.

More information is provided on: <https://www.fema.gov/grants/mitigation>

### FEMA Building Resilient Infrastructure & Communities (BRIC)

FEMA Building Resilient Infrastructure & Communities provides funding for communities looking to implement hazard mitigation projects to protect themselves from natural disasters. BRIC program aims to fund projects that are research-supported, proactive investments and predicts to fund projects that have innovative approaches to partnerships, such as shared funding mechanisms, and/or project design. Eligible projects have to have been included in the community's mitigation projects list in the current FEMA-approved hazard mitigation plan.

- Who is Eligible: All 50 states, U.S. territories, federally recognized tribal governments, and District of Columbia
- Award: Up to \$600,000 per applicant
- Due Date: January 29, 2021, 3 p.m. ET
- Contact: Marlene M. White - (518) 292-2375 - [Marlene.White@dhses.ny.gov](mailto:Marlene.White@dhses.ny.gov)
- Website: <https://www.fema.gov/grants/mitigation/building-resilient-infrastructure-communities>

### National Fish and Wildlife Foundation: Bring Back the Natives grant program

Bring Back the Natives program provides funding to projects that produce measurable outcomes for native fish species of conservation concern. Priority projects will address the leading factors in native fish species decline such as habitat alteration, environmental change, and invasive species.

- Who is Eligible: local, state, federal, and tribal governments and agencies, special districts, non-profit 501(c) organizations, schools and universities.
- Award: Up to \$510,000 in grant funds is available. Grants usually range from \$50,000 to \$100,000.
- Due Date: 2021 dates have not been announced yet, but generally pre-proposal due date is early June and full proposal due date is late July.

- Contact: Kristin Neff - (303) 222-6482 - [Kirstin.Neff@nfwf.org](mailto:Kirstin.Neff@nfwf.org)  
Kate Morgan - (202) 595-2469 - [Katherine.Morgan@nfwf.org](mailto:Katherine.Morgan@nfwf.org)
- Website: [easygrants.nfwf.org](http://easygrants.nfwf.org)

## **United States Department of Agriculture: Emergency Watershed Protection Program (EWP)**

The EWP program, a federal emergency recovery program, helps local communities recover after a natural disaster. According to the EWP Program webpage, the program offers “technical and financial assistance to help local communities relieve imminent threats to life and property caused by floods, fires, windstorms and other natural disasters that impair a watershed”. EWP does not require a disaster declaration by federal or state officials for program assistance to begin, but partial funding must be provided by the sponsor (Eligible sponsors are listed below). The EWP Program cannot be used to address problems that existed before disaster.

- Who is Eligible: Cities, towns, counties, conservation districts, or any federally-recognized Native American tribe or tribal organization. Public and private landowners can also apply for the EWP Program through those sponsors.
- Contact: Paula Bagley - (607) 865-7090 - [paula.bagley@usda.gov](mailto:paula.bagley@usda.gov)
- Website: <https://www.nrcs.usda.gov/wps/portal/nrcs/main/national/programs/landscape/ewpp/>

## **5.2 State Funding**

### **Cornell Local Roads Program**

The Cornell Local Roads Program provides support for municipalities managing local highways and bridges in NYS. Their mission statement found on their website states:

“The Cornell Local Roads Program provides unbiased, timely and exceptional technical assistance and training to highway and public works departments across New York State to help improve the quality and safety of roads and streets. We support local communities through strong collaborations with partners that enhance the sustainability of local highway assets.”

They provide multiple services, which are primarily training classes, as well as some additional resources like an online library containing publications, videos, and software pertaining to highway and bridge management. Training classes even include a Highway School for Highway superintendents. CLRP is the Local Technical Assistance Program for NYS and is funded by the Federal Highway Administration, New York State



Department of Transportation, Cornell University, and participant training fees. More information can be found on <https://www.clrp.cornell.edu/clrp/about.html>.

## **NYS Consolidated Funding Application**

New York State's Consolidated Funding Application (CFA) allows communities to apply for multiple funding projects with just one application. This program was created to make the grant application process easier for communities and serves as a way to reach multiple state funding sources through a single place.

- Website: <https://regionalcouncils.ny.gov/cfa>

Project opportunities that can be applied for through this application include:

### **Green Innovation Grant Program**

The Green Innovation grant program provides funding for projects that improve water quality and administer green stormwater infrastructure in New York State. As stated on the Green Innovation grant program website, they seek to select a project that “maximize opportunities to leverage the multiple benefits of green infrastructure, spur innovation in the field of stormwater management, build capacity to construct and maintain green infrastructure, and/or facilitate the transfer of new technologies and practices to other areas across the State”.

- Who is Eligible: Municipalities, private entities, state agencies, and soil and water conservation districts.
- Award: Grants will be awarded a minimum of 40% up to a maximum of 90% of eligible project costs.
- Contact: Brian Hahn (Manager of Green Policy, Planning and Infrastructure) - (518) 402-6924 - [GIGP@efc.ny.gov](mailto:GIGP@efc.ny.gov)
- Website: <https://www.efc.ny.gov/GreenGrants>

### **Water Quality Improvement Project (WQIP)**

Water Quality Improvement Project provides funding for projects that directly concern documented water quality impairments or protect a drinking water source. WQIP can be applied for through CFA.

- Who is Eligible: Municipalities
- Contact: Division of Water - (518) 402-8179 - [user.water@nyc.dec.gov](mailto:user.water@nyc.dec.gov)
- Website: <https://www.dec.ny.gov/pubs/4774.html>

## **New York State Department of Environmental Conservation (NYSDEC)**

The NYSDEC is a state agency focused on the conservation, enhancement, and enjoyment of environmental resources.

Contact: NYSDEC - (518) 402- 8270

The NYSDEC provides funding for the following projects:

### **Hudson River Estuary Program Grants**

The Hudson River Estuary Program grant provides communities with funding to support projects that promote clean water quality, resilience of communities, river scenery, and conservation of fish, wildlife and their habitats. According to their website, NYSDEC provides funding through the Hudson River Estuary Program to implement Hudson River Estuary Action Agenda priorities. The opportunities are announced as Request for Applications (RFAs) through the Hudson River Estuary Grants Program or as Request for Proposals (RFPs) through the New England Interstate Water Pollution Control Commission (NEIWPC).

- Who is Eligible: Governmental entities, municipalities, and quasi governmental entities
- Contact: Susan Pepe (Grants Manager) - [HREPGGrants@dec.ny.gov](mailto:HREPGGrants@dec.ny.gov)
- Website: <https://www.dec.ny.gov/lands/5091.html>

### **Climate Smart Communities (CSC) Grants**

The Climate Smart Communities grants provide 50/50 matching grants for municipalities looking to implement projects concerning climate mitigation and adaptation. Funds are available for two broad categories- implementation and certification. Implementation projects concern the reduction of greenhouse gas emissions outside the power sector and climate change adaptation. Climate change adaptation surrounds reducing flood risk, increasing natural resiliency, extreme-event preparation, relocation or retrofit of critical infrastructure, and improving emergency preparedness. Certification projects include planning and assessment projects aligned with Climate Smart Communities Certification.

- Who is Eligible: Any county (or New York City borough) city, town, or village of the State of New York.
- Award: Implementation Projects: \$10,000 - \$2,000,00  
Certification Projects: \$10,000 - \$100,000

- Due Date: A due date for 2020 has not been announced yet due the COVID-19 pandemic, but the due date for the previous year was 4:00 pm on July 26, 2019.
- Contact: Myra Fedyniak (Climate Policy Analyst) - (518) 402-8448 - [cscgrants@dec.ny.gov](mailto:cscgrants@dec.ny.gov)
- Website: <https://www.dec.ny.gov/energy/109181.html>

### **BridgeNY**

The BRIDGE NY program, administered by the New York State Department of Transportation (NYSDOT), is available to all municipal owners of bridges and culverts. It will assist all phases of the project. Funding is given in a competitive manner. If selected, the project will be rated on the condition of the structure, the significance and importance of the bridge including traffic volumes, detour considerations, number and types of businesses served and impacts on commerce; and the current bridge and culvert structural conditions.

- Who is Eligible: Any city, county, town, village or other political subdivision, including tribal governments and public benefit corporations.
- Due Date: Due to the COVID-19 pandemic, a due date has not been announced.
- Contact: [BRIDGENY@dot.ny.gov](mailto:BRIDGENY@dot.ny.gov)

## **5.3 Local**

### **Ashokan Watershed Stream Management Program Funding for Infrastructure Improvements**

The AWSMP provides funding for design and engineering of projects to reduce hydraulic constructions or treat channel instability threatening public infrastructure. Projects are developed using NYC DEP Stream Management Program design submission standards. AWSMP does not fund the replacement or maintenance of existing structures and will only fund costs related to enhancing the structure. Municipalities are more likely to receive funding if they use the Ashokan watershed road-stream crossing assessment and prioritization developed by the AWSMP.

- Who is Eligible: Municipalities
- Due Date: October 14, 2020
- Contact: AWSMP office - (845) 688-3047
- Website: <https://ashokanstreams.org/projects-funding/>

## Section 6: Appendices

- A. Cornell Culverts Model Flood Risk Justification
- B. NAACC
- C. Glossary of Terms
- D. Aquatic Connectivity (Hudson River Estuary Program)
- E. Checklist for Municipalities Preparing for Funding
- F. Stream Simulation Design
- G. MOSCAP
- H. Detailed Flood Analyses (FEMA)
- I. HVA and LHCCD acknowledgement
- J. Private Road-Stream Crossings
- K. Dam Inventory
- L. Bibliography

# Flood Risk Data Justification

Cornell Water Resources Institute modeled the flood risk data tables within the inventory document. Below are notes justifying some missing information for several crossings as provided by Cornell staff, Allison M. Truhlar, PhD.

Inaccessible crossings were not modeled for flood risk as necessary parameters were not measured such as the outlet or inlet dimensions. Crossings also missing slope information were not measured as that is another necessary field for the flood risk algorithm. Cornell was notified that slope is an optional field on the NAACC database. Moving forward, all NAACC assessment within NYS will require slope measurements to ensure flood risk is modeled.

For crossings missing slope, "a 'dummy slope' was generated to calculate an estimate of the peak flow through the watershed draining into the culvert. This calculation is based solely on the location of the culvert, and therefore would not be biased by the missing dimension information. The peak flow information is useful if an engineer were to later calculate the capacity of the crossing (Truhlar, 2018)."

Peak flow values are modeled for most crossings, however they are only relevant when the culvert capacity is provided for comparison. In cases where the culvert capacity was not modeled due to missing information, future engineers can collect missing information and calculate the culvert capacity. Crossings that do not have culvert capacity modeled were not included in the ranking system.

Peak flows were based on current estimates calculated by Cornell University. Future peak flows are using projected rainfall estimates for 2050.

"The 'peak\_logical' field indicates whether something was modeled successfully (TRUE), whether it was not modeled due to failing a condition in the code (failed), or whether the crossing information was not document by NYS DEC staff in initial exchanges with Cornell (NA) (Truhlar, 2018)."

Bridges that do not have a box/bridge with abutments or open bottom arch inlet will not be modeled for flood risk.

For further clarification on Cornell Water Resources Institute flood modeling, please contact:

Josephine Archibald  
New York State Water Resources Institute Department  
of Biological & Environmental Engineering  
B60 Riley-Robb Hall  
Cornell University  
607-254-7163  
[jaa78@cornell.edu](mailto:jaa78@cornell.edu)  
<https://wri.cals.cornell.edu>

# NAACC Stream Crossing Survey Data Form Instruction Guide



Developed by the

## North Atlantic Aquatic Connectivity Collaborative

Including: University of Massachusetts Amherst  
The Nature Conservancy  
U.S. Fish and Wildlife Service

Version 1.2 – May 2016

### CONTACTS

**Scott Jackson**

Department of Environmental Conservation  
Holdsworth Hall  
University of Massachusetts  
Amherst, MA 01003  
(413) 545-4743; sjackson@umass.edu

**Alex Abbott**

Gulf of Maine Coastal Program  
U.S. Fish and Wildlife Service  
4R Fundy Road  
Falmouth, ME 04105  
(207) 781-8364; alexoabbott@hotmail.com

For more information, go to: [www.streamcontinuity.org](http://www.streamcontinuity.org)



## **ACKNOWLEDGEMENTS**

The development of this instruction guide and the survey protocol it explains would not have been possible without the effort of many people involved with the NAACC. First and foremost, we would like to thank our colleagues from the NAACC Core Group who worked so diligently to develop and refine the concepts reflected here, and the documents resulting from their many days and hours of effort. The core group includes Rich Kirn of the Vermont Department of Fish and Wildlife, Jessie Levine, Erik Martin, and Michelle Brown of The Nature Conservancy, Jed Wright of the U.S. Fish and Wildlife Service Gulf of Maine Coastal Program, Melissa Ocana and Bob English of the University of Massachusetts Amherst, and Keith Nislow of the U.S. Forest Service. We are particularly thankful to Jessie Levine for her many hours of thorough editing.

In addition, the NAACC relies on a Working Group composed of dozens of professionals working across the region in state and federal agencies and nongovernmental organizations dedicated to improving stream connectivity for the health and resilience of our aquatic and terrestrial ecosystems, as well as safeguarding our infrastructure in the face of a changing climate and increasingly intense, and sometimes devastating storms. Thanks to all those who have lent their time and expertise to making our collaborative successful.

And, finally, thanks to the U.S. Fish and Wildlife Service North Atlantic Landscape Conservation Cooperative for funding this important work.

Alex Abbott & Scott Jackson

## TABLE OF CONTENTS

OVERVIEW .....	3
SURVEY PLANNING .....	4
General Planning.....	4
Safety.....	5
Equipment.....	5
Unmapped Sites and Nonexistent Crossings .....	6
COMPLETING THE SURVEY DATA FORM .....	7
Shaded Boxes.....	7
Site Identification.....	7
Undisturbed Stream Reference Reaches.....	8
Crossing Data .....	8
Structure Data.....	15

## OVERVIEW

This document provides guidance for completing the North Atlantic Aquatic Connectivity (NAACC) Stream Crossing Survey Data Form.

The North Atlantic Aquatic Connectivity Collaborative (NAACC) is a network of individuals from universities, conservation organizations, and state and federal natural resource and transportation departments focused on improving aquatic connectivity across a thirteen-state region, from Maine to Virginia. The NAACC has developed common protocols for assessing road-stream crossings (culverts and bridges) and developed a regional database for these field data. The information collected will identify high priority bridges and culverts for upgrade and replacement. The NAACC will support planning and decision-making by providing information about where restoration projects are likely to bring the greatest improvements in aquatic connectivity.

The survey data form is to be used for an entire road-stream crossing, which may include single or multiple culverts or multiple cell bridges. On the first page, the top of the form contains general information about the crossing, and the bottom half of that page is for data on the first (or only) structure at the crossing. Subsequent pages are used to add data where there are additional culverts or bridge cells. It can be difficult to determine how best to evaluate multiple culvert/cell crossings. Please remember that it is essential to gather all of the data required for each structure (pipe or bridge cell) for accurate assessment of the entire crossing.

Stream crossing survey data can be collected digitally on a variety of devices, including tablet computers and smart phones. While data collected digitally must be reviewed before upload to the NAACC database, data upload can be done in “batches” without the need for manual entry. Paper forms can also be used, with subsequent manual data entry to the NAACC online database. Further instructions for data entry by each of these methods is provided in survey training sessions, and at [www.streamcontinuity.org](http://www.streamcontinuity.org).

***Please be sure to complete every possible element of the field data form.***

# SURVEY PLANNING

## GENERAL PLANNING

Any effort to survey stream crossings should be based on a plan that includes answers to the following key questions:

**1. *Who is primarily responsible for managing the surveys?***

Each NAACC state or region has a coordinator who helps decide on priority areas for survey and how to manage the data once surveys are completed. This coordinator will also plan for, oversee, and collect data from the surveys. Contact the project at [contact@streamcontinuity.org](mailto:contact@streamcontinuity.org) for more information, or refer to the NAACC website to locate a coordinator in your region:

[https://www.streamcontinuity.org/participating\\_states.htm](https://www.streamcontinuity.org/participating_states.htm).

**2. *How will surveyors be trained?***

Training should be arranged through your regional or state coordinator, and includes both classroom and field survey practice. Trainings are posted on

[https://www.streamcontinuity.org/about\\_naacc/training\\_prog.htm](https://www.streamcontinuity.org/about_naacc/training_prog.htm). The most important elements of training are becoming familiar with this instruction manual and gaining practice through survey of a variety of crossings with an experienced surveyor.

**3. *When should surveys be done?***

Ideally, surveys should be conducted during low-flow periods, particularly summer and early fall.

**4. *How should we decide where to survey?***

Consult with your regional coordinator to decide whether surveys will be conducted in one or more watersheds, towns, or counties. Plan to have maps to help you navigate to sites you plan to survey, either copies of existing maps such as the DeLorme Atlas and Gazetteer, or more sophisticated maps from a geographic information system (GIS). When collecting data digitally on a tablet computer or smart phone, survey coordinators must identify and map planned survey sites for your chosen survey area.

For each state in the NAACC region, United States Geological Survey (USGS) HUC-12 subwatersheds have been prioritized for field surveys by the NAACC project team. These subwatersheds were prioritized based on several objectives including brook trout, diadromous fish, and the potential vulnerability of culverts to failure. These prioritized results can be a useful starting place for identifying areas to survey. In addition, there may be locally important watersheds or habitats in your state or region that may help guide location of surveys. To see the NAACC priority subwatersheds in your area, visit the web map at <http://arcg.is/1F2rPJU>. This web map also depicts road-stream crossings symbolized by their estimated restoration potential which can help focus survey efforts within a subwatershed.

**5. *Which sites will be surveyed?***

Work with your state or regional coordinator to decide whether all crossings, or only certain types or sizes of streams will be considered. Some crossing surveys focus primarily on designated *perennial* streams containing most aquatic habitats, while other survey projects include all *ephemeral* and *intermittent* streams. In other cases, certain places in the watershed or town may be identified as highest priority for surveys, based on ecological or other criteria.

**6. *How will we keep track of the sites visited?***

You should maintain records, possibly as notations on paper maps, or in a table listing each planned survey site, showing which sites have been surveyed and when. Organize your survey forms by date, and be sure each survey form is complete. Once data has been entered to the NAACC database

(<https://streamcontinuity.org/cdb2>), you will be able to see all surveyed sites through online maps to verify that you have completed all planned crossings.

**7. *How can we access crossings on major highways, railroads and private land?***

Depending on the scope of your surveys, you should have easy access to stream crossings on most public roads, though it is important to be aware of the right-of-way to avoid inadvertently trespassing on private land. Access to interstate highways and railroads is generally much more limited. For cases with limited access to crossings, you are responsible for contacting the appropriate owner or manager of those crossings to request access to conduct surveys. Similarly, for crossings on private roads, you should make concerted efforts to notify private landowners to request permission to conduct surveys on their lands. It may help to work with a local land trust, town or county governments, or state resource agencies to gain access from these landowners, as they often have similar needs for conducting habitat surveys or other resource assessments. In some survey efforts, when allowed by specific laws in effect in those jurisdictions, it has been considered permissible to survey crossings on private roads, particularly if good faith efforts to notify landowners have been undertaken first, or so long as crossings are not on posted or gated roads.

#### **8. *How can we be sure our data will lead to crossing improvements?***

For your data to be useful in setting stream restoration priorities, we encourage you to collect data as completely and accurately as possible and ensure that the data are entered properly into the database. Finally, be sure that all data, including survey forms and site photographs, whether collected digitally or on paper, are transmitted to your state or regional coordinator for archiving.

## **SAFETY**

Streams can be hazardous places, so take care to sensibly evaluate risks before you begin a survey at each stream crossing. While these efforts to record data about crossings are important, they are not nearly as important as your safety and well-being. Working around roads can be dangerous, so be sure to wear highly visible clothing, preferably safety vests in bright colors with reflective material; some vests have the additional bonus of containing many pockets to hold gear. Take care when parking and exiting your vehicle, and when crossing busy roads.

These surveys are best undertaken by teams of two people. This will facilitate taking measurements, making decisions in challenging situations, and recording data.

Take measurements seriously and carefully, but make estimates if necessary for your safety. Avoid wading into streams – even small ones – at high flows and entering pools of unknown depths, and take care scaling steep and rocky embankments. There are usually ways to effectively estimate some dimensions without risk. For example, an accurate laser rangefinder is a safe way to measure longer distances when conditions are unsafe, such as measuring culvert lengths through them instead of across busy roads.

## **EQUIPMENT**

To collect data on stream crossing structures, you will need several essential pieces of equipment for measuring and recording, and some other items to keep you healthy and safe:

- ✓ **Instruction Guide for the NAACC Stream Crossing Survey Data Form** (this document)
- ✓ **Measuring Implements** in feet and tenths (decimal feet rather than inches)
  - **Reel Tape:** For measuring structure lengths and channel widths; 100 feet.
  - **Pocket Tape:** Best in 6 foot “Pocket Rod” version with no spring to rust.
  - **Stadia Rod:** Telescoping, 13 feet long to measure structure dimensions such as water depth.
- ✓ **Safety Vests:** Brightly colored, reflective vests, preferably with lots of pockets to hold equipment, but most importantly to be seen on the road.
- ✓ **Waders or Hip Boots:** To stay dry, insulate from cold water, minimize abrasions, and allow access to tailwater pools and deeper streams.
- ✓ **Flashlight:** To be able to see features inside long dark structures.
- ✓ **Rangefinder** (optional): To safely take measurements without crossing structures, busy roadways or streams; should be accurate to within one foot for adequate data accuracy.
- ✓ **Sun Protection:** Hat, sunglasses, and sunscreen as needed.

- ✓ **Insect Repellent:** To protect from annoying or dangerous bites.
- ✓ **First Aid Kit:** To deal with any minor injuries, cuts, scrapes, etc.
- ✓ **Cell Phone:** In case of emergency, to coordinate surveys, or to ask questions of coordinators.

#### For Paper Surveys

- ✓ **Stream Crossing Survey Forms:** Best printed on waterproof paper. Bring along more than you expect to use. Even digital surveys should include these in case a digital device becomes inoperable.
- ✓ **Clipboard, Pencils & Erasers**
- ✓ **Stream Crossing Maps:** For planning sites to survey, and for recording sites assessed, a *DeLorme Atlas and Gazetteer* or similarly accurate and updated set of maps with topography is helpful for navigation.
- ✓ **GPS Receiver:** Set GPS to collect data in WGS84 datum, with Latitude and Longitude in decimal degrees.
- ✓ **Digital Camera:** Best if waterproof and shockproof, with sufficient battery power for a full day of surveying, and capable of storing approximately 100 low to moderate resolution images (approximately 100 - 500 kilobyte stored size, generally less than 1 million pixels–1 megapixel). Include batteries or battery charger, and download cable. A backup memory chip can be very useful to have on hand.

#### For Digital Surveys:

- ✓ **Tablet Computer:** Should be waterproof, and preferably shockproof, to be able to survive wet and rugged field conditions. Various mapping applications can be run to allow navigation to planned survey sites, replacing paper maps. For more information on this method of survey, refer to the NAACC Digital Data Collection User's Guide available at [https://www.streamcontinuity.org/resources/naacc\\_documents.htm](https://www.streamcontinuity.org/resources/naacc_documents.htm)
- ✓ **GPS Receiver:** If not integral to the tablet computer, an external GPS device will be needed either to connect to the tablet via Bluetooth or wire, or at the least, to be able to provide correct coordinates for entering to the tablet manually.
- ✓ **Stream Crossing Survey Forms:** As a backup in case digital devices fail.

## **UNMAPPED SITES AND NONEXISTENT CROSSINGS**

Survey teams may encounter unmapped crossings, or it may be unclear whether a crossing they have found in the field is on their map because its location does not match the map. In most cases, the surveyed crossing should be within 100-200 feet of the planned crossing. Survey teams also may encounter unmapped crossings because either the road was not mapped, as in the case of a road built to serve a new housing development, or because of an error in the road or stream data.

If there is no planned crossing near the site you are assessing, you need to assign a temporary *Crossing Code* to that crossing. A *Crossing Code* is composed of the prefix "xy" followed by the latitude and longitude of the site, with decimal degree latitude and longitude values as seven-digit numbers. For instance, a crossing located at 42.32914 degrees north and -72.67522 degrees west, will have the resulting *xy code* = "xy42329147267522," followed by the notation: "NEW XY" to indicate that this crossing site must be added to the map.

Conversely, a crossing may exist on the map but not in the field. If you try to navigate to a site and are certain that there is no crossing in the vicinity, you should select the "No Crossing" option for *Crossing Type* on the field data form. Some crossings may not actually exist due to errors in generating the crossing points. Another possibility is that there may have been a road crossing there at one time, but the crossing has been removed, but may still need to be surveyed to note passage problems. For these sites, you will select the "Removed Crossing" option. Similarly, sometimes an entire stream reach has been moved, particularly underground, in which case you will select the "Buried Stream" *Crossing Type*.

In all cases where a survey crew either cannot locate a mapped crossing or intends to add a new unmapped crossing, it is essential to check the location carefully to minimize navigation and data collection errors.



# COMPLETING THE SURVEY DATA FORM

## SHADED BOXES

The shading on the data form is intended to make the form easier to follow and complete. The different shading sets off elements related to certain groups of information from others.

## SITE IDENTIFICATION

While each crossing will be different from others in its details, many common features will be assessed, measured, or otherwise observed during all surveys. The diagram below contains the basic terminology for key stream crossing features in a simplified overhead view.

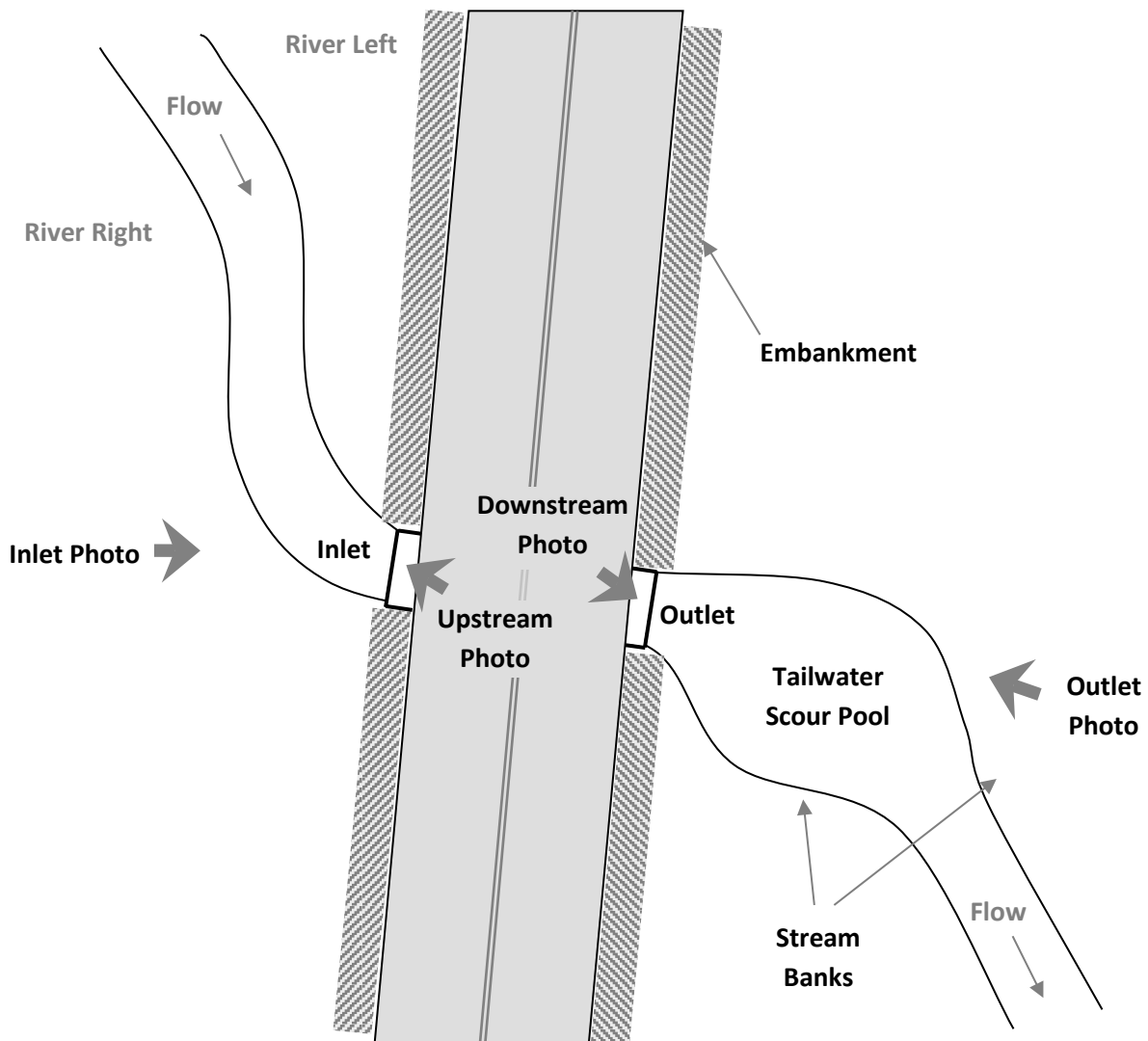

## UNDISTURBED STREAM REFERENCE REACHES

When conducting crossing surveys, elements of this data form require you to understand key characteristics of an undisturbed, “natural” section of the stream (called a *reference reach*) near where the crossing is located. These characteristics include the stream’s approximate width, depth, and velocity, and the type of substrate that predominates there. In general, you will need to go a distance upstream or downstream from the crossing that is between 10 and 20 times the width of the stream to get away from the influence of the crossing. This means for a 10-foot wide stream, you will need to go between 100 and 200 feet upstream or downstream from the crossing to find an undisturbed reach. The distance will be much larger for larger streams. Note that sometimes you will be unable to locate such a reference reach, either because upstream and downstream reaches are too disturbed or modified, or because access is limited, such as by *No Trespassing* signs.

## CROSSING DATA

Complete this section for the entire crossing. Choose only one option for the fields with checkboxes in the crossing data section.

**Crossing Code:** This is the 18-character “xy code” assigned to each planned survey crossing on survey maps. Be very careful to record the correct numbers, as they represent the precise latitude and longitude of the planned crossing, which can be compared with the actual location you record as GPS Coordinates below.

**Local ID:** Optional field for a program’s own coding systems. Does NOT replace the Crossing Code.

**Date Observed:** Date that the crossing was evaluated, following the form *M/D/Y*.

**Lead Observer:** The name of the survey team leader responsible for the quality of the data collected.

**Town/County:** The town or county in which the assessed crossing is located according to the map.

**Stream:** The name of the stream taken from the map, or if not named on the map, the name as known locally, or otherwise list as *Unnamed*.

**Road:** The name of the road taken from the map or from a road sign. Numbered roads should be listed as “Route #”, where # is the route number, with multiple numbers separated by “/” when routes overlap at the crossing (e.g., “Route 1/95”). For driveways, trails, or railroads lacking known names, enter *Unnamed*.

**Road Type:** Choose only one option:

*Multilane:* > 2 lanes, including divided highways (assumed paved)

*Paved:* public or private roads

*Unpaved:* public or private roads

*Driveway:* serving only one or two houses or businesses (paved or unpaved)

*Trail:* primarily unpaved, or for all-terrain vehicles only, but includes paved recreational paths

*Railroad:* with tracks, whether or not currently used

**GPS Coordinates:** Latitude and Longitude in decimal degrees to 5 decimal places. Use of a GPS (Global Positioning System) receiver is required, but your smart phone or tablet computer may include this capability.

Map Datum: It is best to use *WGS84* datum.

Location Format: Use Latitude-Longitude decimal-degrees (often in GPS menu as “hddd.ddddd”).

You should stand above the stream centerline, and ideally on the road centerline, when taking the GPS point, but use your judgment and beware of traffic.

**Location Description:** If there is any doubt about whether someone could find this crossing again, provide enough information about the exact location of the crossing so that others with your data sheet would be confident that they are at the same crossing that you evaluated. For example, the description might include

“between houses at 162 and 164 Smith Road,” “across from the Depot Restaurant,” or “driveway north of Smith Road off Route 193.” This information could also include additional location information, such as a site identification number used by road owners or managers.

**Crossing Type:** If a crossing is found at the planned location, choose the one most appropriate option.

*Bridge:* A bridge has a deck supported by abutments (or stream banks). It may have more than one cell or section separated by one or more piers, in which case enter the number of cells to *Number of Culverts/Bridge Cells*. Enter data for any additional cells in *Structure 2 Data*, *Structure 3 Data*, etc.

*Culvert:* A culvert consists of a structure buried under some amount of fill. If it is a single culvert, you need only complete the first page of the data form.

*Multiple Culvert:* If there is more than one culvert, you must indicate that in *Number of Culverts/Bridge Cells* to the right. Data must be entered in sections for additional structures starting on the second page (*Structure 2 Data*, *Structure 3 Data*, etc.). Count ALL structures, regardless of their size.

*Ford:* A ford is a shallow, open stream crossing, in which vehicles pass through the water. Fords may be armored to decrease erosion, and may include pipes to allow flow through the ford (*vented ford*).

If a planned crossing cannot be found or surveyed, the site will fit one of the following types:

*No Crossing:* There is no crossing where anticipated, usually because of incorrect road or stream location on maps. No further data is required. (Be sure you are in the correct location.)

*Removed Crossing:* A crossing apparently existed previously at the site but has been removed, so the stream now flows through the site with no provision for vehicles to cross over it. Continue to complete the survey form to the extent possible. Include information in Crossing Comments to explain your observations. For instance, indicate if an old culvert pipe is seen at the site, or if removal of the previous crossing structure left the stream with problems for aquatic organism passage.

*Buried Stream:* The planned crossing site does not include an inlet and/or outlet, likely because a stream previously in this location has been rerouted, probably underground. In this case, survey is not possible, and no further data is required.

*Inaccessible:* Survey is not possible because roads or trails to the crossing are not accessible. This may be due to private property posting, gates, poor condition, or other factors. Record in Crossing Comments why the site is inaccessible. No further data is required.

*Partially Inaccessible:* Use this option when you can access a crossing well enough to collect some but not all required data. This is most likely to occur when you cannot access either the inlet or outlet side of a crossing and cannot reasonably estimate the dimensions or assess things like inlet grade, outlet grade, scour pool or tailwater armoring.

*No Upstream Channel:* This option is for places where water crosses a road through a culvert but no road-stream crossing occurs because there is no channel up-gradient of the road. This can occur at the very headwaters of a stream or where a road crosses a wetland that lacks a stream channel (at least on the up-gradient side).

*Bridge Adequate:* Coordinators have the option of using this classification for large bridges for which it is obvious that they present no barrier to aquatic organism passage. Observers may collect and enter data for these crossings but these data are not required.

**Number of Culverts/Bridge Cells:** For all Bridges with multiple sections or cells, and for all multiple culverts, you must enter the number of those cells or culvert structures here.

**Photo IDs:** All surveys should include a minimum of four digital photos of the following: crossing inlet, crossing outlet, stream channel upstream of crossing, and stream channel downstream of crossing. These photos are

immensely useful in setting priorities for restoration. Note that photos of buried streams are optional but recommended.

It is essential that all photos be associated with the correct crossing. If you take photos with a digital camera (and sometimes when using a smart phone or tablet computer), you should record the photo numbers assigned by the camera on the survey form in the space for each photo perspective. To record the correct photo numbers from any camera, each person taking photos must be familiar with the numbering system of the camera used. Record the ID number of each photo in the blanks on the data form.

While you may take multiple photos at a site in order to choose the best ones later, you must record on the data form the ID numbers of all photos taken at the site. It can be very helpful to have one or more additional photos, especially when important characteristics are not captured on the four required photos. For instance, if there is extreme erosion at the site, or if other aspects of the crossing make it a likely barrier to connectivity, it is useful to capture these with one or two additional photos.

A simple way to know which photos were taken at a particular site is to use a black marker on a white dry-erase board to record the date and Crossing Code, and to have the first photo at the crossing show this white board displaying the date and Crossing Code. The white board should be strategically placed in the photo so that it is legible and does not block key features of the crossings. This will make the photo readily identifiable with the appropriate crossing. Some people have noted that white dry-erase boards and white paper reflect so much light that they are often “washed out” in the photos, making the codes written on the board impossible to read; use of a small blackboard and chalk may be preferable depending on light conditions.

Here are several additional tips for taking useful photos:

- Always include more than just the structure or stream area you are photographing; it is better to capture more context. Remember that with digital photos, we can zoom in to see detail.
- Including a stadia rod in photos of the inlet and outlet can be valuable to verify some measurements, and as a general reference for scale.
- When available, use a date/time stamp to code each photo.
- Set your camera to record in low to medium resolution so that the photos do not take up too much space on the memory card and when downloaded for storage. To minimize storage space but still allow a reasonable quality image, each photo should be between 100 and 500 kilobytes in size when downloaded. This often equates to a camera resolution setting of “1 Megapixel.”
- Review photos at the site to discard bad photos and to be sure all perspectives are well represented.
- If you haven’t used the camera before, practice to be sure you know how to take photos in dark or mixed light situations, as these often exist when surveying stream crossings.

The following are some examples of useful photos:



**Upstream**



**Downstream**



**Flow Condition:** Check the appropriate box to indicate how much water is flowing in the stream. Normally, the value selected for the first perennial crossing of the day will hold for all perennial sites in the area during that day, unless a rainfall event changes the situation. Choose only one option.

*No Flow:* No water is flowing in the natural stream channel; this option is typical of extreme droughts for perennial streams, or frequent conditions for intermittent or ephemeral streams.

*Typical-Low:* This is the most commonly used and expected value for surveys conducted during summer low flows, particularly on perennial streams. Water level in the stream will typically be below the level of non-aquatic vegetation, exposing portions of stream banks and bottom.

*Moderate:* This value is selected when recent rains have raised water levels at or above the level of herbaceous (non-woody) stream bank vegetation.

*High:* This value is selected only rarely, when flows are very high relative to stream banks, making crossing surveys very difficult or impossible, normally due to very recent, or ongoing major rain events. Avoid surveying crossings under high flows as data will not reflect more frequent flow conditions.

**Crossing Condition:** Check one box that best summarizes the condition of the crossing, based on your observations of the overall state or quality of the crossing, including all structures, particularly the largest or those carrying most of the flow. We are primarily trying to identify crossings in immediate danger of failing or in imminent need of replacement, as well as those that have been very recently installed. Focus primarily on the condition of structure materials.

*OK:* This is the value given to the vast majority of crossings. Many crossings have deficiencies such as surface rust, dents, dings, or cracks which do not indicate risk of failure.

*Poor:* This value is intended for structures where the material appears to be failing, such as metal culverts with rot (not just surface rust), or concrete, stone or wooden structures that are already collapsing, or in danger of immediate failure (see images below as examples).



*New:* This value is assigned only to a crossing that has been installed very recently. Look for unblemished structures with new riprap and/or vegetative bank stabilization.

*Unknown:* This value applies to all sites where the condition of the crossing cannot be assessed, such as when submerged.

**Tidal Site:** Sites in tidal areas will often require additional survey to fully assess aquatic organism passage. This element is primarily meant to identify sites in a tidal zone. Choose only one option. Survey of tidal crossings is best done within one hour of low tide to improve access and provide the most useful data. Freshwater streams influenced by tides, often at great distances from the ocean, are more difficult to identify. Coordinators working in such areas should provide Lead Observers with guidance on survey of such sites.

*Yes:* Evidence shows that tidal waters regularly reach the crossing site. Evidence includes a clear wrack line (line of debris) marking the limit of recent tides. Other indications include observation of salt marsh plants (*spartina spp.*, not upland vegetation or freshwater wetland plants like cattails and common reed (*phragmites*), though both of these wetland plants *can* exist on the fringes of salt marshes) in the vicinity.

*No:* Sites are not tidal if downstream banks obviously contain plants that could not survive salt water inundation, such as alders, maples, ferns, etc., normally seen on stream banks in upland areas.

*Unknown:* Select when unsure of whether a crossing is in a tidal zone.

**Alignment:** Indicates the alignment of the crossing structure(s) relative to the stream at the inlet(s). Compare the crossing centerline (green lines below) to a centerline of the stream where it enters the crossing (red lines below).

*Flow-Aligned:* The stream approaches the crossing at less than a 45 degree angle from the centerline.

*Skewed:* The stream approaches the crossing structure(s) at an angle greater than 45 degrees from the centerline. Note that for some crossings the centerline is not perpendicular to the road.

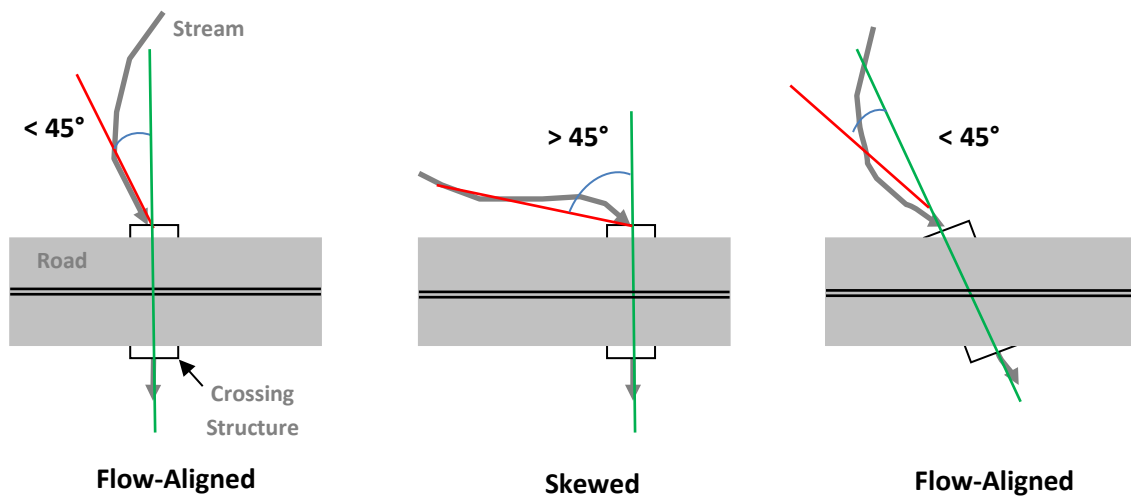

**Road Fill Height:** Within 1 foot, measure the height of fill material between the top of the crossing structure(s) and the road surface. This is best measured with two people when the road surface or fill height is above a surveyor's height, with one person holding a stadia rod, and the other sighting the elevation of the road surface from the side (see diagram below). For multiple culverts with differing amounts of fill over them, provide an average fill height.

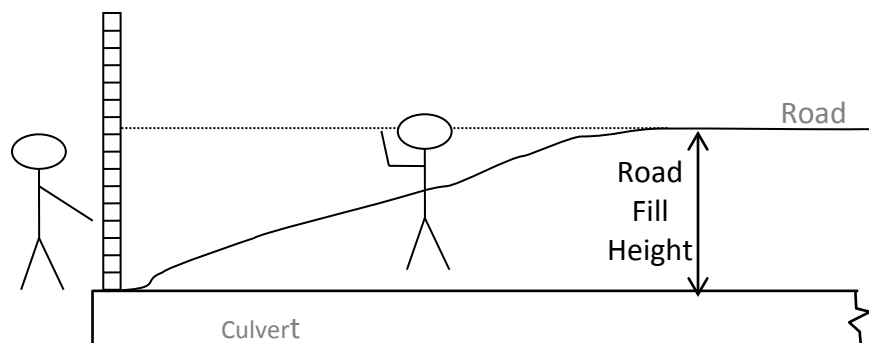



**Bankfull Width** (optional measurement): This is a measure of the active stream channel width at bankfull flow, the point at which water completely fills the stream channel and where additional water would overflow into the floodplain. Estimates of the frequency of bankfull flows vary, but they may happen as often as twice a year, or only once every one or two years. Each state or regional coordinator will define whether or not you should measure bankfull width in your surveys. When done with high confidence (see next metric), bankfull width can be an extremely useful measurement, but it can be difficult and time consuming, and it will not be possible for all surveyors and sites (even with experienced surveyors). The first step is to identify bankfull flow indicators in an undisturbed reach, and the second step is to measure the width from bank to bank at those locations. Indicators of bankfull flow (shown in the photographs below as the red line) include<sup>1</sup>:

*Abrupt transition from bank to floodplain:* The point of change from a vertical bank to a more horizontal surface is the best identifier of bankfull stage, especially in low-gradient meandering streams.



*Top of point bars:* The point bar consists of channel material deposited on the inside of meander bends. Set the top elevation of point bars as the lowest possible bankfull.

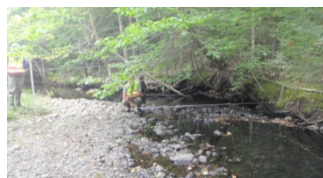

*Bank undercuts:* Maximum heights of bank undercuts are useful indicators of bankfull flow in steep channels lacking floodplains.

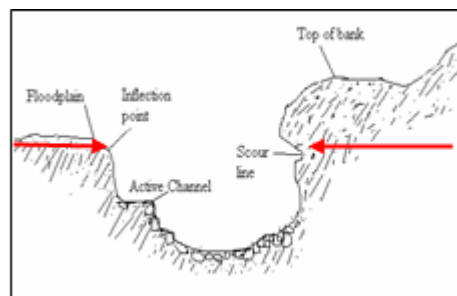

*Changes in bank material:* Changes in the particle size of sediment (rocks, soil, etc.) may indicate the upper limits of bankfull flows, with larger sediments exposed to more frequent channel-forming flows.



*Change in vegetation:* Look for the low limit of woody vegetation, especially trees, on the bank, or a sharp break in the density or type of vegetation.

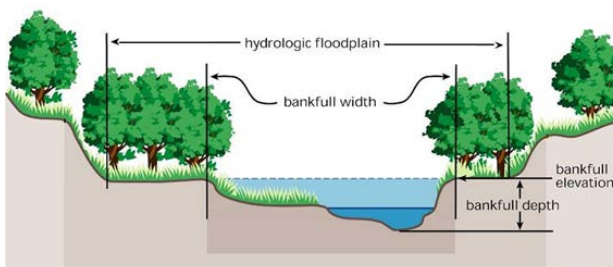

<sup>1</sup> Adapted from Georgia Adopt-A-Stream "Visual Stream Survey" manual. Georgia Department of Natural Resources, 2002.

**Bankfull Width Confidence:** This qualifies your assessment of Bankfull Width based on your experience with its measurement and whether sufficient criteria were met in your measurements. Choose only one option.

*High:* Select this option only when you are highly confident that your assessment of Bankfull Width meets the following criteria:

- Clear indicators are present to define the limits of Bankfull Width.
- The recorded value is an average of at least three measurements in different locations.
- All measurements of Bankfull Width were taken in undisturbed locations well upstream or downstream of the crossing.
- No tributaries enter between the crossing and your area(s) of measurements.
- No measures taken at stream bends, pools, braided channels, or close to stream obstructions.

*Low/Estimated:* Select this when **any** of the above criteria cannot be met.

**Constriction:** Regardless of whether you measured Bankfull Width above, this element assesses how the width of the crossing (including all of its structures) compares to the width of the natural stream channel. Refer to the above section on determining Bankfull Width for reference. Two other ways of assessing the width of the natural stream channel consider the *active channel* and the *wetted channel*.

The *active channel* is the area of the stream that is very frequently affected by flowing water. The width of the *active channel* can often be very close to the Bankfull Width when stream banks are very steep. The *wetted channel* is simply the area of the stream that contains water at the time of survey, which may be significantly less than the *active channel*, depending on flow.

Refer to the general illustrations below, and check the appropriate description from the list below to assess how constricted the flow of the stream is by the crossing compared to either the *bankfull*, *active*, or *wetted* channel. Choose only one option.

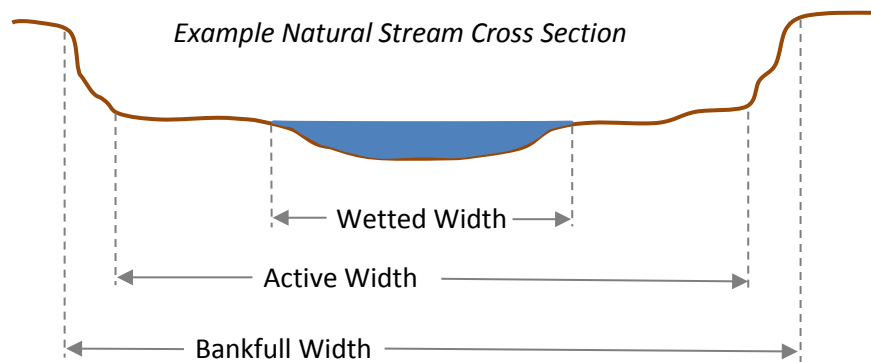

*Example Culvert Cross Section*

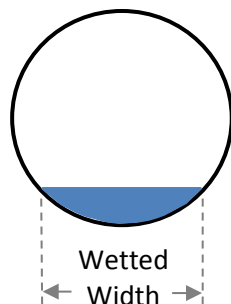

*Example Multiple Culvert Cross Section*

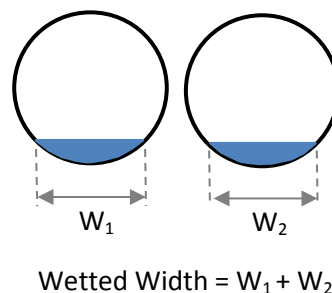

*Severe:* The total width of the crossing (sum of widths of all crossing structures) is less than 50% of the bankfull or active width of the natural stream, or the total *wetted width* of the crossing is less than 50% of the wetted width of the stream.

*Moderate:* The crossing is *greater than* 50% of the bankfull or active width of the natural stream, but less than the full bankfull or active channel width.

*Spans Only Bankfull/Active Channel:* The crossing encompasses the approximate width of the bankfull or active channel.

*Spans Full Channel & Banks:* The crossing completely spans beyond the *Bankfull Width* of the natural stream, as often evidenced by banks within the crossing structure.

**Tailwater Scour Pool:** This is a pool created downstream of a crossing as a result of high flows exiting the crossing. Use as a reference natural pools in a portion of the stream that is outside the influence of the crossing structure. A scour pool is considered to exist when its size (a combination of length, width, and depth) is larger than pools found in the natural stream. Check *Large* if the length, width **or** depth of the pool is two or more times larger than of pools in the natural stream channel. Otherwise, check *Small* if the pool is between one and two times the length, width, **or** depth of pools in the natural channel.

*None:* There is no difference between the length, width, or depth of the tailwater pool compared with reference pools, or no tailwater pool exists at the site.

*Small:* The tailwater pool is between one and two times the length, width, or depth of reference pools.

*Large:* The tailwater pool is more than twice the length, width or depth of reference pools.

**Crossing Comments:** Use this area for brief comments about any aspect of the overall crossing survey that warrants additional information. Do not use this box for comments about particular structures; comment boxes for each structure are provided elsewhere on the form.

## STRUCTURE DATA

Choose only one option for structure data fields **except** when identifying Internal Structures and Physical Barriers.

When there are multiple culverts and/or bridge cells, number them from left to right, while looking downstream toward the culvert inlet. The left-most structure is Structure 1, and structure numbers increase to the right. See examples below.



**For each structure, you will complete the following information.**

**Structure Material:** Record here the primary material of which the structure is made, i.e., the material that makes up the majority of the structure. When in doubt, focus on the material that is most in contact with the stream. If a structure is made of two materials, such as a bridge with concrete abutments and a steel deck structure, a metal culvert that has been lined along its entire bottom with concrete, or a crossing with different types of structures at inlet and outlet, select *Combination*. Choose only one option.





Metal



Concrete



Plastic



Rock/Stone



Combination

**Outlet Shape:** Refer to the diagrams on the last page of the field data form, and record here the structure number that best matches the shape of the structure opening observed at the inlet of the culvert. This is usually simple, but when a shape seems unusual, you should carefully choose the most reasonable option from among the eight available. We collect this information to be able to find the “open area” inside the structure above any water or substrate, so the shape is vital to accurately calculate area. Choose only one option.

**1 - Round Culvert:** This is a circular pipe. It may or may not have substrate inside, even though the diagram on the field form shows a layer of substrate. It may be compressed slightly in one dimension, and should be considered round unless it is truly squashed so that it reflects a type 2 shape below.



**2 - Pipe Arch/Elliptical Culvert:** This is essentially a squashed round culvert, where the lower portion is flatter, and the upper portion is a semicircular arch, or as on the right below, more of a pure ellipse. It may or may not have substrate inside (the diagram on the field form shows a layer of substrate).



**3 - Open Bottom Arch Bridge/Culvert:** This structure will often look like a round culvert on the top half, but it will not have a bottom. There will be some sort of footings to stabilize it, either buried metal or concrete footings, or concrete footings that rise some height above the channel bottom. There will be natural substrate throughout the structure. To distinguish between an embedded Pipe Arch Culvert and an Open Bottom Arch, note that the sides of the Pipe Arch curve inward in their lower section, while the sides of the Open Bottom Arch will run straight downward into the streambed substrate or to a vertical footing. Beware of confusion between an Open Bottom Arch and an embedded Round Culvert; Open Bottom Arches tend to be larger than most Round Culverts. This shape could also be selected for certain bridges that have a similar arched shape and are not well represented by other bridge types (Types 5, 6, 7, below).



**4 - Box Culvert:** These structures are usually made of concrete or stone, but sometimes of corrugated metal with a slightly arched top. Typically, they have a top, two sides, and a bottom.

A box culvert without a bottom, called a bottomless box culvert, should be classified as a *Box/Bridge with Abutments* (#6, below). If you cannot tell if the structure has a bottom, classify it as a *Box/Bridge*



with Abutments (#6). The images below show *Box Culverts* (#4).



5 - *Bridge with Side Slopes*: This is a bridge with angled banks up to the bottom of the road deck. This type will have no obvious abutments, though they may be buried in the road fill.



6 - *Box/Bridge with Abutments*: This is a bridge or bottomless box culvert with vertical sides.



7 - *Bridge with Side Slopes and Abutments*: This is a bridge with sloping banks and vertical abutments (typically short) that support the bridge deck. (Arrows below show the abutments.)



*Ford*: A ford is a shallow, open stream crossing that may have a minimal structure to stabilize where vehicles drive across the stream bottom. The arrows below indicate the length of a ford, to be measured as Dimension  $L$ , described below.



*Unknown*: Select when a structure's shape is unidentifiable for any reason. Typically, the inlet shape may be unidentifiable because it is submerged or completely blocked with debris.

*Removed*: Select when the structure is no longer present.

**Outlet Armoring**: Select from the options to indicate the presence and extent of material placed below the outlet for the purpose of diffusing flow and minimizing scour. The most common form of outlet armoring is a layer of riprap (angular rock) placed below the outlet. A few pieces of rock that may have fallen into the stream near the structure's outlet **do not** constitute outlet armoring. Armoring of the road embankment and stream banks should not be confused with armoring of the stream bottom at the outlet. Choose only one option.



Refer to the photos below for examples of each option.

*None:* This situation represents the majority of crossing structures. You may observe rocks that have fallen from the embankment or that are natural to the stream. Most cascades do not constitute armoring unless specifically put in place to minimize outlet scour.



*Not Extensive:* There is a layer of material covering an area *less than 50% of the stream width* placed purposefully below the outlet specifically to minimize the effects of scour.



*Extensive:* Select this option only if you observe an extensive layer of material covering an area more than 50% of the stream width, which was put in place specifically to minimize scour at the outlet.



**Outlet Grade:** Outlet grade is an observation of the relative elevation of the structure to the streambed and how water flows as it exits the structure. This is not an assessment of stream slope (gradient).  
Choose only one option.

*At Stream Grade:* The bottom of the outlet of the structure is at approximately the same elevation as the stream bottom (there may be a small drop from the inside surface of the structure down to the stream bottom), such that **water does not drop downward at all** when flowing out of the structure. Such outlets can normally be considered to be “backwatered” by the downstream stream bed.

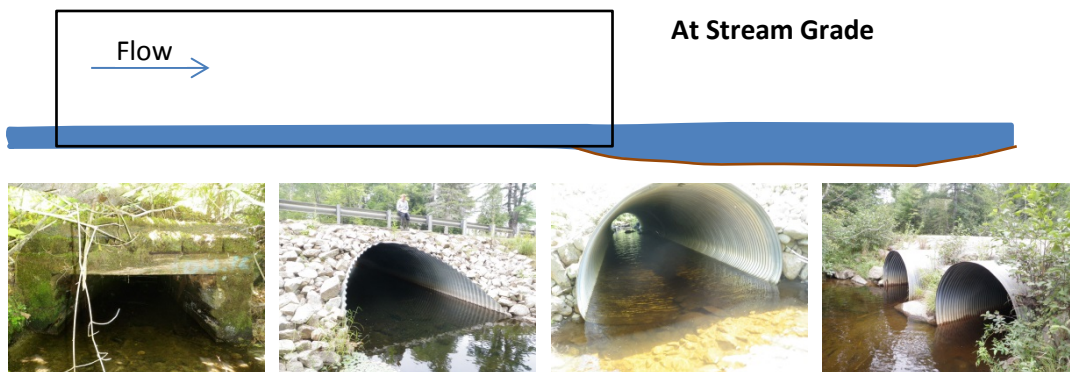

*Free Fall:* The outlet of the structure is above the stream bottom such that **water drops vertically** when flowing out of the structure.

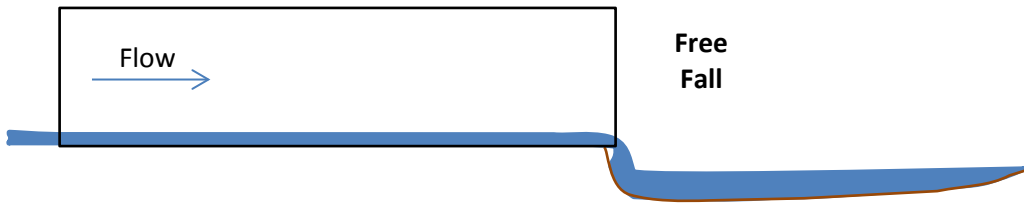

**Cascade:** The outlet of the structure is raised above the stream bottom at the outlet such that **water flows very steeply downward across rock or other hard material** when flowing from the structure. Think of this as series of small waterfalls at the outlet.

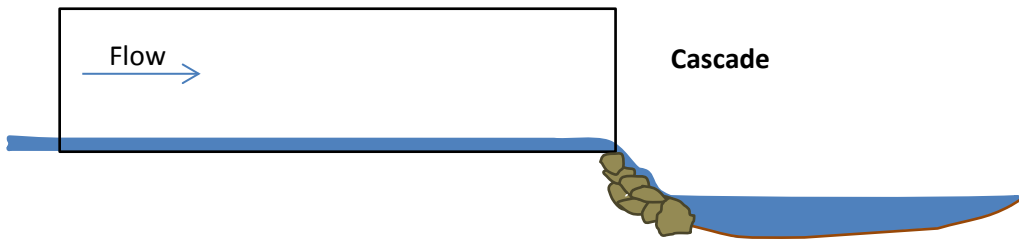

**Free Fall Onto Cascade:** The outlet of the structure is raised above the stream bottom at the outlet such that **water drops vertically onto a steep area of rock or other hard material, then flows very steeply downward** until it reaches the stream.

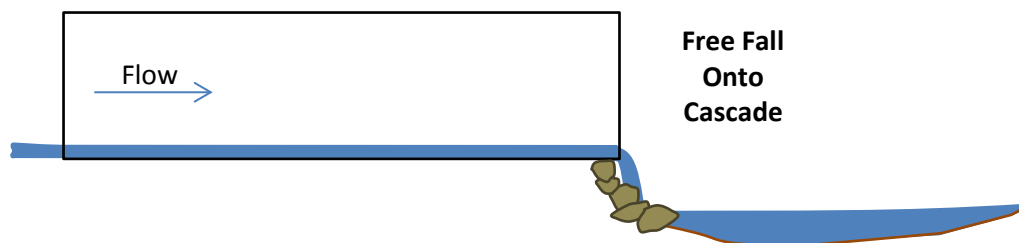

**Outlet Dimensions:** **Four** measurements should be taken at the outlet and **inside** all structures, and an additional **two** should be taken for all structures with an Outlet Grade marked as *Free Fall*, *Cascade* or *Free Fall*



*Onto Cascade*. The four measurements are shown on the diagrams on the last page of the field data form, and the others are illustrated below.

**Dimension A, Structure Width:** To the nearest tenth of a foot, measure the full width of the structure outlet according to the location of the horizontal arrows labeled **A** in the diagrams. Take this measurement inside the structure.

**Dimension B, Structure Height:** To the nearest tenth of a foot, measure the height of the structure outlet according to the location of the vertical arrows labeled **B** in the diagrams. Take this measurement inside the structure. If there is no substrate inside, this will be the full height of a structure from bottom to top. If there is substrate inside, this will be the height from the top of the stream bottom substrate up to the inside top of the structure.

**Dimension C, Substrate/Water Width:** To the nearest tenth of a foot, measure the width of **either** the substrate layer in the bottom of the structure, or of the water surface, whichever is **wider** according to the general location indicated by the arrows labeled **C** in the diagrams. This measurement must be taken inside the structure near the outlet. Some rules of thumb for Dimension C are below:

- When there is no substrate in a structure, measure only the width of the water surface.
- When there is no water in a structure, but there is substrate, measure the width of substrate.
- When there is no substrate or water in a structure, C = 0.

**Dimension D, Water Depth:** To the nearest tenth of a foot (except when < 0.1 foot, to the nearest hundredth of a foot), measure the average depth of water in the structure at the outlet according to the location of the vertical arrows labeled **D** in the diagrams. This measurement must be taken inside the structure. When there are lots of different depths due to a very uneven bottom, take several measurements and record the average. For fords, measure the water depth at the downstream limit of the ford.

**Outlet Drop to Water Surface:** This measurement is only applicable to *Free Fall*, *Cascade* and *Free Fall Onto Cascade* outlets. To the nearest tenth of a foot, measure from the inside bottom surface of the structure (**not** the top of the water) down to the water surface outside the structure. For *Cascade* and *Free Fall Onto Cascade* structures, measure to the surface of the water at the bottom of the cascade. Refer to the diagrams and photos below for guidance; the red arrows indicate where to make this measurement. When assessing *At Stream* Grade structures or dry structures in streams without flow or water in an outlet pool, this measurement must be *zero*.

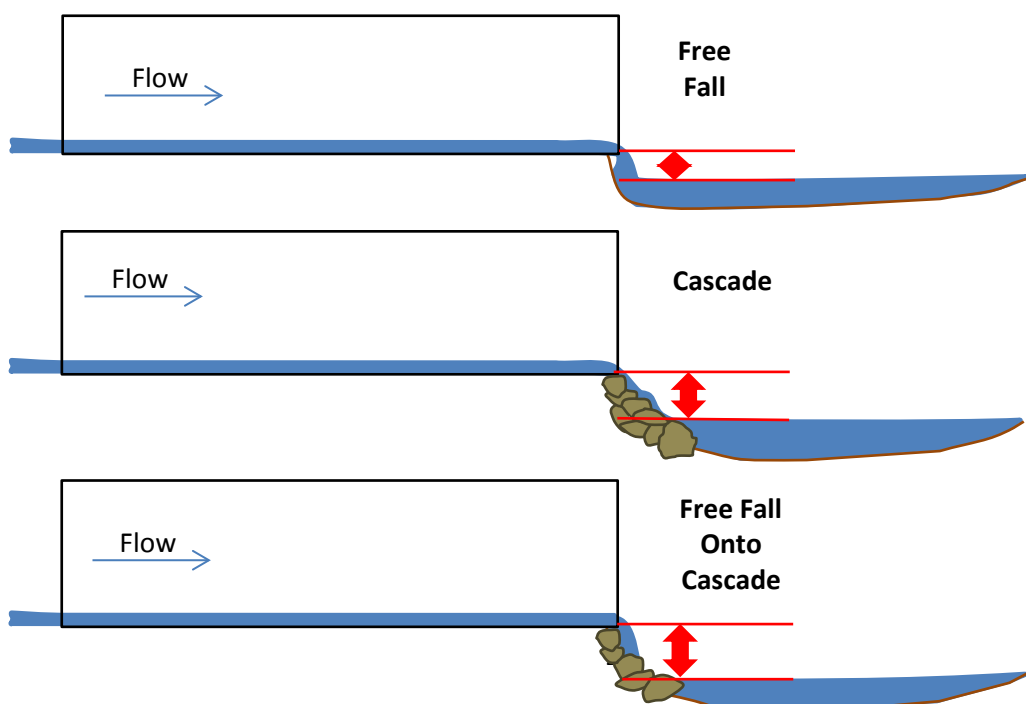



Free Fall



Free Fall

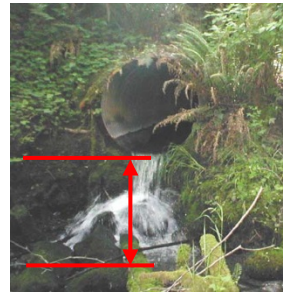

Free Fall Onto Cascade



**Outlet Drop to Stream Bottom:** To the nearest tenth of a foot, measure from the inside bottom surface of the structure (**not** the top of the water) down to the stream bottom at the place where the water falls from the outlet. For *At Stream Grade* structures, this may be hard to measure, and may be a very small drop. For *Cascade* and *Free Fall Onto Cascade* structures, measure the full vertical drop to the stream bottom at the end of the cascade. Refer to the diagrams below for guidance.

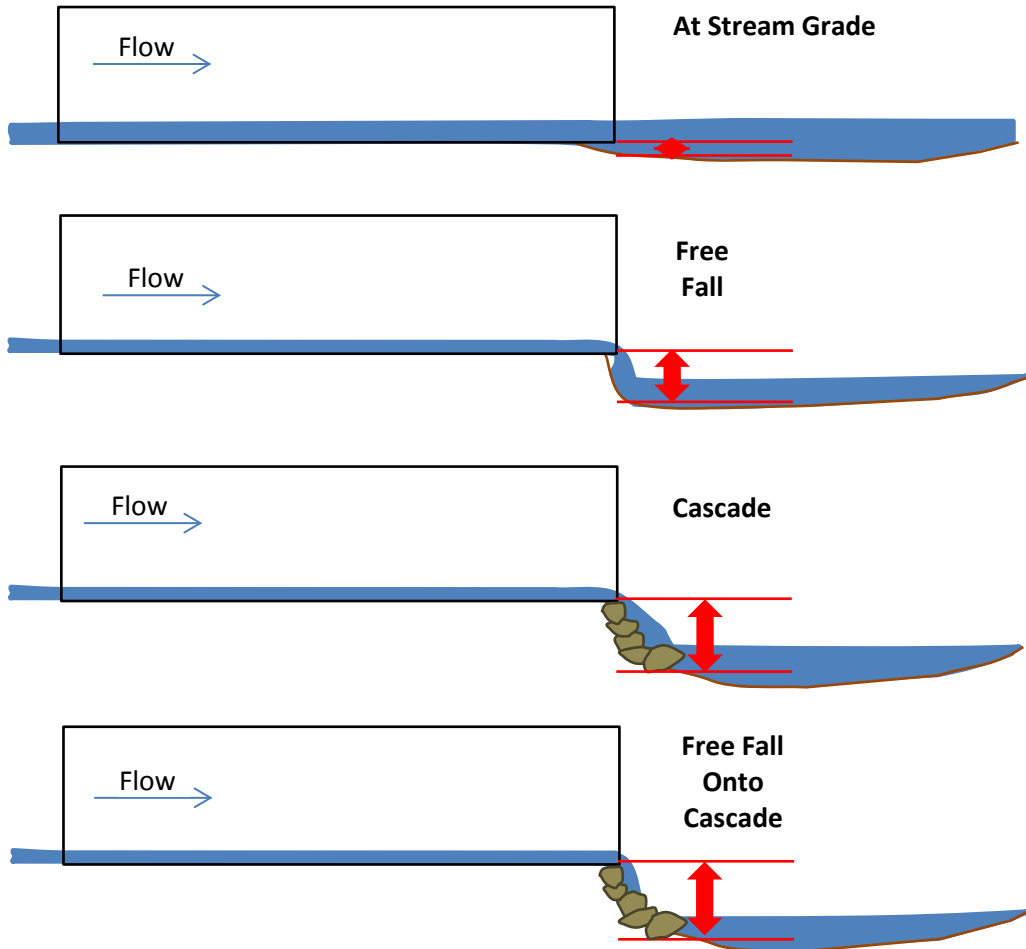

**Abutment Height, Dimension E:** This measurement is taken only when surveying a *Bridge with Side Slopes and Abutments* (#7 structure). To the nearest foot, measure the height of the vertical abutments from the top of the side slopes up to the bottom of the bridge deck structure.



**Structure Length, Dimension L:** To the nearest foot, measure the length of the structure at its top.

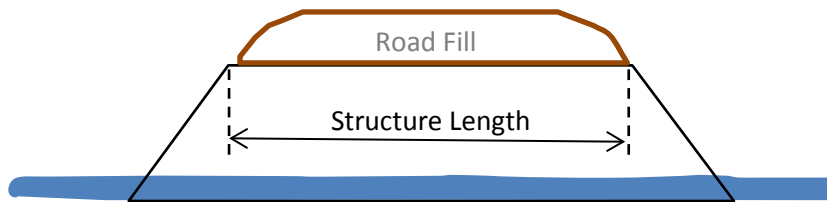

**Inlet Shape:** Refer to the diagrams on the last page of the field data form, and record here the number that best matches the shape of the structure at its outlet. Refer to the instructions for **Outlet Shape** for examples and photos.

**Inlet Type:** Choose only one option for the style of a culvert inlet, which affects how water flows into the crossing, particularly at higher flows. The drawings here are meant as general guides, but refer to the photos below for more specific images of each type.

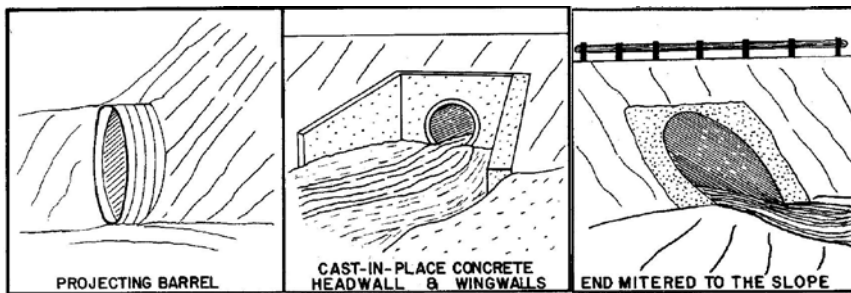

**Projecting:** The inlet of the culvert projects out from (is not flush with) the road embankment.



**Headwall:** The inlet is set flush in a vertical wall, often composed of concrete or stone.





**Wingwalls:** The inlet is set within angled walls meant to funnel water flow. These walls can be composed of the same material as the culvert, or different material. It is relatively rare to see wingwalls without a headwall.



**Headwall & Wingwalls:** The inlet is set flush in a vertical wall, and has angled walls to funnel flow.



**Mitered to Slope:** The inlet is angled to fit **flush with the slope of the road embankment**. Note that many mitered culverts project out from the embankment, and should be recorded as *Projecting*.



**Other:** There may be some other inlet characteristics that do not match any of the above types and which may limit flow into the culvert (but are not *Physical Barriers*), in which case select *Other*, and explain in *Structure Comments*.

**None:** The inlet does not have any of the above features or characteristics.



**Inlet Grade:** An observation of the relative elevation of the stream bottom as it enters the structure. This is not an assessment of stream slope (gradient). Choose only one option.

**At Stream Grade:** The inlet of the structure is at approximately the same elevation as the stream bottom upstream of the structure.

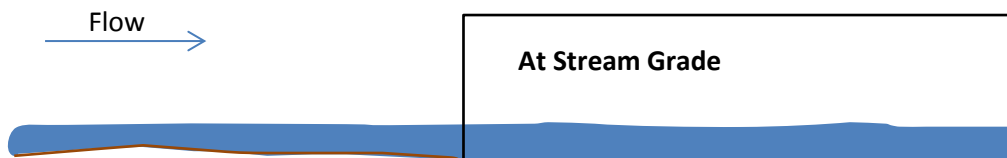



*Inlet Drop:* Water in the stream has a near-vertical drop from the stream channel down into the inlet of the structure. This usually occurs because sediment has accumulated above the inlet. The drop should be very obvious and not typical of natural drops in that stream. If there is a debris blockage or dam at the inlet, use **Physical Barriers** to record those features, and mark *At Stream Grade* here.

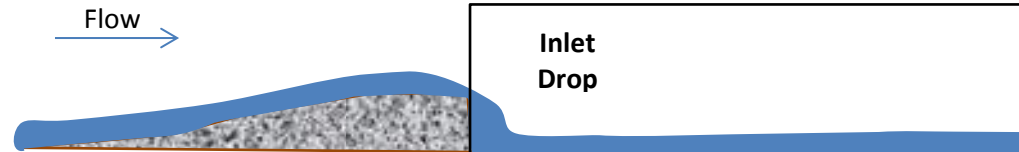

*Perched:* The inlet of the structure is set too high for the stream, and little water passes through the structure during normal low summer flows, though the stream has water upstream and downstream of the crossing. The structure inlet is above the surface of water in the stream. Water can enter the structure only at higher flows. This is a relatively rare condition, found mostly on very small streams. At such sites, there is generally water backed up above the inlet. In some cases water may be “piping” underneath the structure.

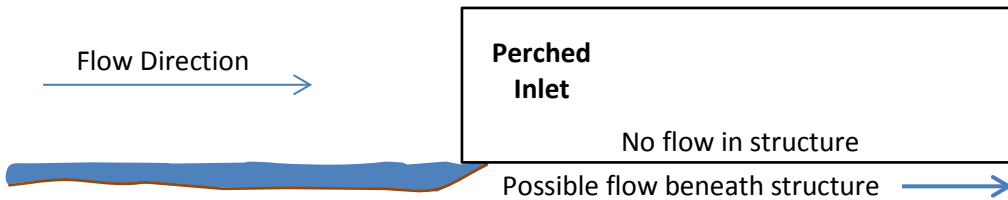

*Clogged/Collapsed/Submerged:* The structure inlet is either full of debris, collapsed, or completely underwater (not usually all three), making inlet measurements impossible. This may be found in places where beavers or debris have plugged a structure inlet so completely that water has backed up and covered the inlet, or where a crossing has collapsed to the point that it cannot be measured at its inlet.

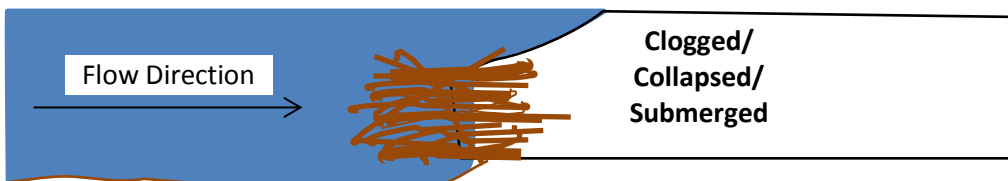





*Unknown:* The inlet cannot be located or observed, or for some other reason you cannot determine the *Inlet Grade*, or take any inlet measurements.

**Inlet Dimensions:** There are four basic measurements to take at the inlet and outlet of each structure; these four measurements are to be made inside the structure. These are shown on the diagrams on the last page of the field data form.

*Dimension A, Structure Width:* To the nearest tenth of a foot, measure the full width of the structure inlet according to the location of the horizontal arrows labeled **A** in the diagrams. Take this measurement inside the structure.

*Dimension B, Structure Height:* To the nearest tenth of a foot, measure the height of the structure inlet according to the location of the vertical arrows labeled **B** in the diagrams. Take this measurement inside the structure. This may be the full height of a culvert pipe if there is no substrate inside, or if there is substrate, it will be the height from the top surface of the substrate up to the inside top of the structure.

*Dimension C, Substrate/Water Width:* To the nearest tenth of a foot, measure the width of either the substrate layer in the bottom of the structure, or the water surface, whichever is wider, according to the general location indicated by the arrows labeled **C** in the diagrams. Take this measurement inside the structure at the inlet. Some rules of thumb for Dimension C are below:

- When there is no substrate in a structure, measure the width of the water surface.
- When there is no water in a structure, but there is substrate, measure the width of substrate.
- When there is no substrate or water in a structure, C = 0.

*Dimension D, Water Depth:* To the nearest tenth of a foot (except when < 0.1 foot, to the nearest *hundredth* of a foot), measure the average depth of water in the structure at the inlet according to the location of the vertical arrows labeled **D** in the diagrams. This measurement must be taken inside the structure. When there are many different water depths due to a very uneven structure bottom, take several measurements and record the average. For fords, measure the water depth at the upstream limit of the ford.

**Slope %:** (Optional) Calculate or estimate the percent slope of the crossing from inlet to outlet by using one of several optional methods described below. Note that this measurement or estimate can be important to calculating the hydraulic capacity of the crossing, and is difficult to measure accurately without the proper tools. In general, the ease and accuracy of these different methods relates directly to the cost of the tools needed, with the most easy-to-use and accurate measurement tools costing more.

- 1) The simplest accurate method for measuring slope is to use an accurate laser rangefinder/hypsometer with a slope function, and to measure from inlet to outlet at the same height in relation to each invert. For instance, a person with a known eye height of 5.0 feet sights from one end of a culvert by standing on top of the inlet to the 5.0 foot mark on a stadia rod on top of the outlet. You must take at least three measurements and average them, and be sure the instrument is set to read in percent, not degrees.
- 2) Another method for measuring slope is to use an auto level or other accurate survey instrument to measure the vertical difference between inlet and outlet invert elevations, then dividing this number by the length of the structure, and multiplying by 100.

- 3) The next best approach is to use a clinometer that measures slope to the nearest half percent, measuring from a fixed point above one invert (inlet or outlet) to the same height above the opposite invert such as described above under method 1. Many clinometers include both percent and degree scales; be sure to use the percent scale.
- 4) Another less accurate approach is to sight from a fixed elevation above the inlet invert with a hand level to a stadia rod at the outlet invert, to take the difference in height between the two points, divide by the structure length, and multiply by 100.

**Slope Confidence:** Rate the confidence you have in your slope measurement or estimate according to the criteria below:

*High:* Used method 1 above, taking multiple measurements and averaging them, or used method 2 above.

*Low:* Used methods 3 or 4 above, taking multiple measurements and averaging them.

**Internal Structures:** Indicate the presence of structures inside the crossing structure. These may include baffles or weirs used to slow flow velocities and help to pass fish, as well as trusses, rods, piers or other structures intended to support a crossing structure, but which may interfere with flow and aquatic organism passage. See photos below for examples of internal structures. Choose any option(s) that apply.

*None:* There are no apparent structures inside the crossing structure.

*Baffles/Weirs:* Baffles (partial width) or weirs (full width, notched or not) are incorporated into the structure, either inside or at its outlet, to help aquatic organisms move through the structure.

*Supports:* Some type of structural supports, such as bridge piers, vertical or horizontal beams, or rods apparently meant to support the structure, are observed inside the crossing structure.

*Other:* Structure(s) other than the categories above are present inside the crossing structure. Provide a very brief description of those structures here, or more fully describe them under **Structure Comments**. **Do not** include here items such as bedrock, material blockages, structural deformation, or inlet fencing to exclude beavers, which will be recorded below as **Physical Barriers**.



**Structure Substrate Matches Stream:** Choose only one option based on a comparison of the substrate (e.g., rock, gravel, sand) inside the structure and the substrate in the natural, undisturbed stream channel.

*None:* Select this option when there is very little (e.g., a thin layer of silt or a few pieces of rock) or no substrate inside the structure.

*Comparable:* The substrate inside the structure is similar in size to the substrate in the natural stream channel.

*Contrasting:* The substrate inside the structure is different in size from the substrate in the natural channel.



*Not Appropriate:* The substrate inside the structure is very different in size (usually much larger) than the substrate in the natural stream channel. Imagine turtles that typically move along a sandy stream trying to traverse an area of large cobbles, angular riprap or boulders (rarely observed).

*Unknown:* There is no way to observe if there is substrate inside the structure or what type it is. Select this option when deep, fast, or dark water or other factors do not allow direct observation.

**Structure Substrate Type:** Choose only one option from the table below to indicate the most common or dominant substrate type inside the structure. If you are certain that the structure contains substrate, but cannot assess the type, select *Unknown*. If there is no substrate in the structure, select *None*.

Substrate Type	Feet	Approximate Relative Size
<i>Silt</i>	< 0.002	Finer than salt
<i>Sand</i>	0.002 – 0.01	Salt to peppercorn
<i>Gravel</i>	0.01 – 0.2	Peppercorn to tennis ball
<i>Cobble</i>	0.2 – 0.8	Tennis ball to basketball
<i>Boulder</i>	> 0.8	Bigger than a basketball
<i>Bedrock</i>	Unmeasurable	Unknown - buried

**Structure Substrate Coverage:** Choose one option, based on the extent of the substrate inside the crossing structure as a **continuous** layer across the entire bottom of the structure from bank to bank (side to side).

*None:* Substrate covers less than 25% of the length of the structure, or there is no substrate inside the structure at all.

*25%:* Substrate covers *at least* 25% of the length of the structure.

*50%:* Substrate covers *at least* 50% of the length of the structure.

*75%:* Substrate covers *at least* 75% of the length of the structure.

*100%:* Substrate forms a **continuous** layer throughout the **entire** structure.

*Unknown:* It is not possible to directly observe whether substrate forms a continuous layer on the structure bottom.

**Physical Barriers:** Select any of these barrier types in or associated with the structure you are surveying, but do not include here information already captured in **Outlet Grade**. Note here additional barriers, including those associated with Inlet Grade or blockages, or Internal Structures. If a barrier feature affects more than one structure at a crossing (e.g., a beaver dam), include it for all affected structures. Refer to the photos below for examples of physical barriers.

Note that some structures have a combination of physical barriers. Check all that apply.

*None:* There are no physical barriers associated with this structure aside from any already noted in **Outlet Grade**.

*Debris/Sediment/Rock:* Woody debris or synthetic material, rock, or sediment blocks the flow of water into or through the structure. This can consist of wood or other vegetation, trash, sand, gravel, or rock. Do not check this option if you observe only very small amounts of debris that are likely to be washed away during the next rain event. Also, do not confuse sediment inside a structure that constitutes an appropriate stream bed with an accumulation that limits flow or passage of organisms.



*Deformation:* The structure is deformed in such a way that it significantly limits flow or inhibits the passage of aquatic organisms. This does not include minor dents and slightly misshapen structures.



*Free Fall:* In addition to its **Outlet Grade**, which may include a *Free Fall*, the structure has one or more **additional** vertical drops associated with it. These may include a dam at the inlet, a vertical drop over bedrock inside the structure, or some other feature likely to inhibit passage of aquatic organisms. Note that a *Free Fall* inside a structure is often more limiting than similar size drops found in an undisturbed natural reach of the same stream which occur where there may be multiple paths for organisms to follow. A *Free Fall* can exist because of a debris blockage, so both physical barriers would be recorded.



*Fencing:* The structure has some sort of fencing, often at the inlet to deter beavers. Depending on the mesh size of that fencing, it may directly block the movement of aquatic and terrestrial organisms, and it may become clogged with debris. If also blocked with debris, be sure to check *Debris/Sediment/Rock* as a **Physical Barrier** type as well.



*Dry:* There is no water in this structure, though water is flowing in the stream. Note that if you recorded *No Flow* for crossing Flow Condition, you should not select *Dry* here, as we expect a dry structure at a dry crossing; it is not in itself a physical barrier. This barrier type helps to identify passage problems associated with overflow or secondary crossing structures.



*Other:* There may be different situations that do not fit clearly into one of the above categories, but may still represent significant physical barriers to aquatic organism passage. Use this option to capture such situations, and add information in Structure Comments. Below are examples of some unusual physical barriers which may not fit under Physical Barrier categories listed above.



These are examples of structures with a combination of physical barriers. Multiple relevant barrier types should be selected.



**Severity:** Choose only one option for each surveyed structure, and rank the severity based on an assessment of *the cumulative effect of all physical barriers affecting that structure* according to the table that follows. Do not consider information already captured in **Outlet Grade**. Decide on an overall severity for each structure by considering all the different Physical Barriers present. If any barrier affects more than one structure at a crossing, it should be included in the severity rating for each structure affected. Refer to the table below for guidance in choosing the **Severity** rating.

Physical Barrier	Severity	Severity Definition
<b>None</b>	<i>None</i>	No physical barriers exist - <b>apart from</b> Outlet Grade
<b>Debris/Sediment/Rock</b> <i>Logs, branches, leaves, silt, sand, gravel, rock</i>	<i>None</i>	None beyond few leaves or twigs as may occur in stream
	<i>Minor</i>	< 10% of the open area of the structure is blocked
	<i>Moderate</i>	10% - 50% of open area blocked
	<i>Severe</i>	> 50% of open area of structure blocked
<b>Deformation</b> <i>Significant dents, crushed metal, collapsing structures</i>	<i>None</i>	Small dents and cracks – insignificant effect on flow
	<i>Minor</i>	Flow is limited < 10%
	<i>Moderate</i>	Flow is limited between 10% - 50%
	<i>Severe</i>	Flow is limited > 50%
<b>Free Fall</b> <i>Vertical or near-vertical drop</i>	<i>None</i>	No vertical drop exists - <b>apart from</b> Outlet Grade
	<i>Minor</i>	0.1 - 0.3 foot vertical drop - <b>apart from</b> Outlet Grade
	<i>Moderate</i>	0.3 - 0.5 foot vertical drop - <b>apart from</b> Outlet Grade
	<i>Severe</i>	> 0.5 foot vertical drop - <b>apart from</b> Outlet Grade
<b>Fencing</b> <i>Wire, metal grating, wood</i>	<i>None</i>	No fencing exists in any part of the structure
	<i>Minor</i>	Widely spaced wires or grating with > 0.5 foot (6 inch) gaps
	<i>Moderate</i>	Wires or grating with 0.2 - 0.5 foot (~ 2-6 inches) spacing
	<i>Severe</i>	Wires or grating with < 0.2 foot (~ 2 inch) spacing
<b>Dry</b>	<i>Minor</i>	May be passable at somewhat higher flows
	<i>Moderate</i>	Not likely passable at higher flows
	<i>Severe</i>	Impassable at higher flows
<b>Other</b>	<i>Minor</i>	Use best judgment based on above standards
	<i>Moderate</i>	Use best judgment based on above standards
	<i>Severe</i>	Use best judgment based on above standards

**Water Depth Matches Stream:** Compare the water depth inside the structure with the water depth in the natural stream channel away from the influence of the crossing. Choose only one option.

**Yes:** The depth in the crossing falls within the range of depths naturally occurring in that reach of the stream and for comparable distances along the length of the stream. For example, if a structure has a water depth of 0.2 feet through the entire structure’s length of 60 feet, and there comparable sections of the stream with a 0.2 foot water depth for approximately 60 feet of the channel, select Yes.

**No-Shallower:** This means that the water depth in the crossing is less than depths that occur naturally in a similar length of the undisturbed stream, or the shallower depth through the structure covers a greater length than occurs in the natural stream.

**No-Deeper:** This means that the water depth in the crossing is greater than depths that occur naturally in a similar length of the undisturbed stream. This is rarely observed.

**Unknown:** A comparison of structure depth to natural stream depth is not possible.

**Water Velocity Matches Stream:** Compare the water velocity inside the structure with the velocity in the natural stream channel away from the influence of the crossing. Choose only one option.

*Yes:* The water velocity in the crossing falls within the range of velocities naturally occurring in that reach of the stream for comparable distances. If velocities in the crossing are observed in the natural stream channel, and those velocities persist over the same distance as the structure length, select Yes.

*No-Faster:* This means that the water velocity in the structure is greater than velocities that occur naturally in a similar length of the undisturbed stream, or the velocity through the structure persists over a longer distance than occurs in the natural stream.

*No-Slower:* This means that the velocity in the crossing is less than velocities that occur naturally in a similar length of the undisturbed stream. This is rarely observed.

*Unknown:* A comparison of structure velocity to natural stream velocity is not possible.

**Dry Passage Through Structure?** Consider this question two different ways, depending on whether water is flowing through the structure. Choose only one option.

*If there is water flowing in the structure:* Is there a continuous dry stream bank through at least one side of the structure that allows the safe movement of terrestrial or semi-aquatic animals, and does this dry pathway connect to the stream banks upstream and downstream of the structure?

*If there is no water flowing in the structure:* then there is continuous dry passage through the structure.

*Yes:* A continuous bank connects upstream, through the structure, and downstream, or there is otherwise continuous dry passage through the structure.

*No:* There is no dry passage, the dry passage is not continuous, or the dry passage through the structure does not connect with stream banks upstream or downstream.

*Unknown:* It is not possible to determine if continuous dry passage exists through this structure.

**Height Above Dry Passage:** If there is dry passage through the structure, measure the average height from the dry stream bank to the top of the structure directly above (i.e., the clearance) to the nearest tenth of a foot. If both stream banks are dry and connected, record the higher measurement. If the structure has no water flow, measure the average height above the bottom of the structure or dry stream bed to the top of the structure.

**Comments:** Use this area to briefly comment on any aspects of the structure needing more information. Enter comments about the overall crossing in the **Crossing Comments** box.



## C. Glossary of Terms

### Glossary of Terms

**Aquatic organism** – An aquatic organism lives in water for at least a portion of their life.

**Bankfull**– Bankfull is an established height at a given location along a river or stream, above which a rise in water surface will cause the river or stream to overflow the lowest natural stream bank somewhere in the corresponding reach.

**Bankfull discharge** – Bankfull discharge is the dominant channel forming flow with a recurrence interval seldom outside the 1 to 2-year range.

**Bankfull width- The wetted width of the stream occurring at Bankfull.**

**Clear Span-The maximum inside width of a non-circular pipe or bridge. Cover height** - The amount of fill material above a road stream crossing structure.

**Design Load- The sum of all vertical forces (i.e. soil weight, passing vehicles, etc.) applied to a buried culverts or bridge.**

**Flood resiliency** – Flood resiliency is the ability for the Town to withstand and recover from flood crisis.

**Freeboard** - The distance between normal water level and the bottom of the road stream crossing structure.

**Geomorphic** –Response of river and stream channels to various types of natural and human-caused disturbances including floods.

**Head cut** - A head cut in stream geomorphology, is an area of instream instability and erosional feature of streams with an abrupt vertical drop that can be perpetuated through the river system until equilibrium of channel dimensions and slope is attained.

**Hydraulic capacity** - The amount of water that can pass through a structure or watercourse.

**Intermittent stream** – An intermittent stream is a stream which normally ceases to flow for weeks or months each year.

**Perennial stream** – A perennial stream is a stream or river (channel) that has continuous flow in parts of its stream bed all year round during years of normal rainfall.

**Recurrence Interval** - Statistical techniques, through a process called frequency analysis, are used to estimate the probability of the occurrence of a given precipitation event. The recurrence interval is based on the probability that the given event will be equaled to or exceeded in any given year. Ten or more years of data are required to perform a frequency analysis for the determination of recurrence intervals. Of course, the more years of historical data the better—a hydrologist will have more confidence on an analysis of a river with 30 years of record than one based on 10 years of record.<sup>1</sup>

<sup>1</sup> <https://water.usgs.gov/edu/100yearflood.html>

**Recurrence Intervals and Probabilities of Occurrences**

<b>Recurrence interval, in years</b>	<b>Probability of occurrence in any given year</b>	<b>Percent chance of occurrence in any given year</b>
100	1 in 100	1
50	1 in 50	2
25	1 in 25	4
10	1 in 10	10
5	1 in 5	20
2	1 in 2	50

Regional regression – Regional regression equations are based on statistical relations between (1) streamflow statistics of interest computed from applicable records of the stations and (2) basin and climatic characteristics, for which data are typically readily available.

Road Stream Crossing – Road stream crossings are location where a road, paved or unpaved, crosses over a body of water within the physical extents of all supporting infrastructure (i.e. the proposed crossing infrastructure, wingwalls, etc.)

StreamStats - StreamStats is a USGS Web application that queries an assortment of Geographic Information Systems (GIS) analytical tools to calculate peak discharges for certain recurrence intervals. The calculations were established from publicly available US Geological Service research (USGS SIR 2006-5112 “Magnitude and Frequency of Floods in New York”) which established a relationship between watershed characteristics and peak discharges. StreamStats also is a USGS web application that calculates bankfull dimensions from publicly available US Geological Service research (USGS SIR 2009-5144 “Bankfull Discharge and Channel Characteristics of Streams in New York State”) which established a relationship between watershed characteristics and bankfull dimensions.

Stormwater - Stormwater is water that originates during precipitation events and snow/ice melt that either soak into the soil (infiltrate), evaporates, or runs off and ends up in nearby streams, rivers, or other water bodies.

Wetland - A wetland is a distinct ecosystem that is inundated by water, either permanently or seasonally, where oxygen- free processes prevail.



# AQUATIC CONNECTIVITY

## Identifying Barriers to Organisms and Hazards to Communities

### Problem Road Culverts

**Poorly designed and undersized culverts are barriers to aquatic organisms and hazards to communities during storms.** Streams are linear habitats for aquatic and semi-aquatic species such as American eel, herring, stream salamanders, turtles and crayfish. Road crossings can fragment streams into small pieces, preventing organisms from accessing critical habitats.

**Culverts also may be infrastructure liabilities and flooding hazards for communities.** During storms, undersized or improperly installed culverts can become clogged with debris or overwhelmed, leading to road flooding, stream bank erosion, or even washout of the whole road.



Culverts such as this these can constrict the natural flow of the stream, have a perched outlet that only strong swimmers can jump and contain no natural streambed. Many culverts and dams fragment

**Municipalities can receive help prioritizing culverts that could be upgraded, benefitting aquatic organisms and communities' bottom lines.**

Hudson River Estuary Program Culvert Prioritization Project  
Road-Stream Crossings Assessed for Passability and Capacity, Updated 2019

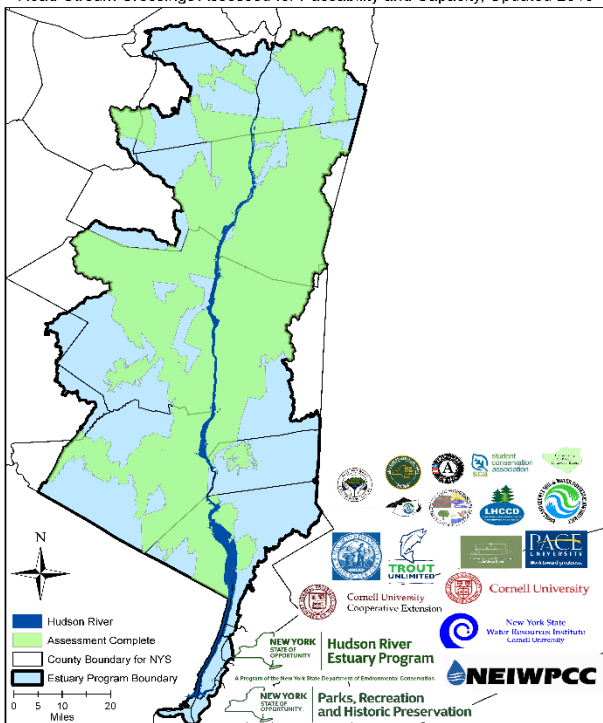

Studies have found that about two-thirds of crossings are not fully passable to aquatic organisms. The NYSDEC Hudson River Estuary Program, other NYSDEC branches, Soil and Water Conservation Districts, and interested county and local partners are working to reconnect tributaries within the Estuary watershed by surveying and prioritizing impassable and undersized culverts. Road crossings with unnatural stream bottoms, a perched outlet where a culvert adds an unnatural step to the stream, or other conditions are often barriers to organisms that need to go up and down streams.

Cornell University hydrologists model each crossing for the maximum storm interval (return period) the crossing could pass without spilling over the road. Undersized culverts are more likely to flood the road and washout during large storms. Emergency replacement of failed culverts costs more money and disrupts essential services such as hospital access during flood events. **This project connects interested communities with funding sources to replace impassable, undersized culverts with fully passable, properly sized culverts.**

## Empowering Communities

After the assessment work, communities have data on each crossing's passability and capacity scoring information. This data is also available on the Cornell WRI [Aquatic Connectivity Map](#) and the [North Atlantic Aquatic Connectivity Collaborative database](#). Estuary Program staff are available for technical assistance and presentations to help communities use the information. Culvert assessments have been conducted in approximately 54.4% of the Hudson River Estuary Program boundary with the help of many partners.



Scenic Hudson Land Trust received a grant to improve the aquatic organism passability and reduce the flooding hazard of this vital piece of infrastructure.

**To help communities reconnect their streams and proactively remove flooding hazards, Estuary Program grants can fund these planning and mitigation steps.**

- 1.) **Assess Culverts and Bridges** for aquatic organism passability and storm capacity by partner organizations or Estuary Program staff.
- 2.) **Prioritize Problem Culverts** within a management plan. After the crossings have been assessed and modeled, municipalities can rank crossings by passability, capacity and local needs. This document can be added to a Natural Resource Inventory or Hazard Mitigation Plan.
- 3.) **Design Replacements** through conceptual or shovel-ready engineering plans. This process also addresses relevant permits required for a construction mitigation project.
- 4.) **Fix Problem Culverts** by upgrading infrastructure to be fully passable to organisms and reduce flooding hazards.

Removing harmful and unnecessary stream barriers will benefit our resident and migratory fish, as well as all the other organisms that use our streams. New York has seen a dramatic increase in the amount of rain falling during large storms, and climate change projections suggest that will continue. Planning for fully passable crossings for organisms also means planning for structures capable of handling more frequent and intense storm events. This project gives communities a clear understanding of where problem stream barriers are and provides funding to fix them.

### CONTACT INFORMATION

#### Megan Lung

Environmental Analyst, Hudson River Estuary Program/New England Interstate Water Pollution Control Commission

#### New York State Department of Environmental Conservation

21 South Putt Corners Road, New Paltz, NY 12561

P: (845) 633-5449 | F: (845) 255-3649 | [Megan.Lung@dec.ny.gov](mailto:Megan.Lung@dec.ny.gov)

[www.dec.ny.gov](http://www.dec.ny.gov)

### KEY POINTS

**Partners have assessed over 10,000 crossings**

- 20% of these are substantial barriers to aquatic organisms
- 71% of crossings are undersized
- Problems are more pronounced for locally owned roads

## E. Checklist for Municipalities Preparing for Funding Opportunities

### **Checklist for municipalities preparing for funding opportunities**

Info needed for applications to help answer questions such as: Is the project ready to go? Will it have a meaningful impact on the identified problem? Are the costs necessary and logical?

Culvert ID:

Location map included/attached?

Pictures included/attached?

Funding Source(s) sought:

	Topics	Town Answers/Notes
General	Municipality	
	Primary contact person(s)	
	Watershed management plans? (local or regional)	
Culvert/Road-specific	Road crossing/ location description <b>NAACC</b>	
	Who owns the road/crossing? ( <i>Does the municipality have permission to work there?</i> )	
	Owners upstream/downstream? <b>Parcel Mapper</b>	
	GPS coordinates <b>NAACC</b>	
	<b>NAACC</b> score	
	Current structural condition <b>Local records, NAACC</b>	
	When was this culvert replaced/ installed? <b>Local</b>	
	Recorded damages to road and/or structure over past 25 years <b>Local</b>	
	Flooding history <b>Local, any disaster declarations?</b>	
	Community/municipality primarily served by the crossing <b>Local</b>	
Data on traffic density available or needed? <b>Highway dept.?</b>		

Stream	Tributary/stream name (if any)	
	State Stream classification <b>Hudson Valley Natural Resource Mapper</b>	
	Name of HUC 12 watershed <b>HVNR Mapper</b>	
<hr/>		
Flooding	RP (Return Period) <i>[statistical year flood this structure can pass, e.g. 100-year flood]</i> <b>WRI</b>	
	Is the location in a FEMA floodplain? <b>Columbia County Parcel Mapper</b>	
	Future flooding model from 2050? <b>WRI</b>	
<hr/>		
Ecological	Located in important area for rare plants or animals? (Eel – current or historic?) <b>HVNR mapper, Local</b>	
	Located within significant natural community? <b>HVNR mapper</b>	
	Water quality: Is this an impaired stream? High Quality? <b>Stream Condition Index</b>	
	Local land use, zoned uses <b>Local</b>	
	Where does this location's watershed fall in regards to HREP priority streams? (Rated 1 thru 20) <b>NAACC website (not on database): NAACC Watershed Prioritization map</b>	
	State Stream Standard ( <i>Is this a trout stream/spawning stream?</i> ) <b>HVNR Mapper</b>	
	Is this in or near a DEC-regulated/NWI wetland? <b>HVNR Mapper</b>	
	Other significant biodiversity or habitat data?	
	Is this a biologically important barrier? <b>HVNR Mapper</b>	
<hr/>		

<b>Road/Culvert improvements</b>	Designs for improved structure: Describe repairs/improvements needed	
	Improved safety and mobility? ( <i>Improving a sidewalk, sight lines, etc.</i> )	
	Describe in detail the improvement of route access needs for critical services, other needs for route, etc. <i>Emergency evacuation route? Will failure strand residents?</i> <b>Local</b>	
	Surveys of structure: Does it exist? If not, who would do it? <b>Local</b>	
	How does the improvement fit within zoning and/or comprehensive plan? ( <i>If the town doesn't have a plan, can the grant be used to develop one in part?</i> )	
	Permits needed/anticipated <b>DEC Permitting staff</b>	
	<i>Estimated and itemized structure costs:</i>	
	Engineering costs <b>Local/Engineering Firm</b>	
	Equipment / Materials <b>Local/Hwy dept</b>	
	Personnel costs <b>Local/Hwy dept</b>	
	Road rebuild costs <b>Local/Hwy dept</b>	
	Cost/Benefit analysis <b>Local</b>	
	Other municipal offices involved and contacted (Planning, Highway, Zoning, etc.) <b>Local</b>	
	Are there other properties/structures nearby that will benefit? <b>Local</b>	
Smart Growth law compatible? <b>(aka. Promotes resilient infrastructure vs. increased suburban/exurban development)</b> <a href="https://www.dot.ny.gov/programs/smart-planning/smartgrowth-law">https://www.dot.ny.gov/programs/smart-planning/smartgrowth-law</a>		

	Possible Matching funds/ resources/contributions for services? List groups that may be interested. <b>Local knowledge</b>	
	Is this location identified in a hazard mitigation plan?	
	Environmental Justice Community? Does the project improve an area with underserved communities? ( <i>may be relevant to some applications</i> ) <b>Local</b>	
<b>Stakeholders/Partners: Potential letters of support: List names and contact info</b>	Town officials	
	Adjacent landowners affected	
	Regional fisheries biologists	
	Regulators (DEC, Army Corps of Engineers, Soil & Water)	
	NRCS	
	Local environmental groups?	
	Local Conservation Advisory Committee	
	Columbia County Environmental Management Council	
	Watershed Groups?	
	Other Potential Partners?	

## **F. Stream Simulation Design (SSD)**

Stream simulation is a method for designing and building road-stream crossings that mimic the natural stream channel. It aims to prevent habitat fragmentation by providing continuity through crossing structures and allowing unrestricted movements for aquatic organisms. SSD replicates physical characteristics of the natural channel upstream of the structure. Wildlife movement and natural processes can continue if the structure was not there at all.

Components of SSD allow for a dynamic channel that can adjust during high water periods and allow proper hydraulic capacity as well as passage of varying sized debris. These are three general rules to follow to achieve the goal of maintaining healthy ecological connectivity as well as safe transportation networks while designing crossings (Forest Service Stream-Simulation Working Group 2008):

1. The design should fit both the stream and the road, not just the road.
2. Minimum intervention in the stream process results in the least risk of failure.
3. Crossings should present no greater challenge to organism movement than the stream being crossed.

Specific components of SSD that follow these principles include (Forest Service Stream-Simulation Working Group 2008):

- Structure width is equivalent to or exceeds the bankfull width of the natural channel.
- Structure substrate should have similar mobility and stability properties to that of the natural bed material of the stream channel.
- Provide sufficient hydraulic capacity and passage of debris during a 100-year flood.
- Provide adequate space between 100-year flood water level and top of the structure utilizing a head-water-to-depth ratio less than 0.8, allowing room for debris to pass without clogging the structure.
- The stream within the structure should have the capability to adjust dimensions in response to a wide range of floods and sediment or wood inputs without compromising the movement needs of aquatic organisms or the hydraulic capacity of the structure.

Although SSD structures may have a higher initial cost, they may save significantly more money in the long run. Long-term maintenance and replacement costs of both the structure and road must be assessed when planning a crossing. It's key to learn which structures best meet project objectives by comparing their total costs to the benefits they offer (Forest Service Stream-Simulation Working Group 2008). More information can be found at:

<https://www.fs.fed.us/eng/pubs/pdf/StreamSimulation/>



# Multi-Objective Stream Crossing Assessment Protocol (MOSCAP) Field Assessment Training

---

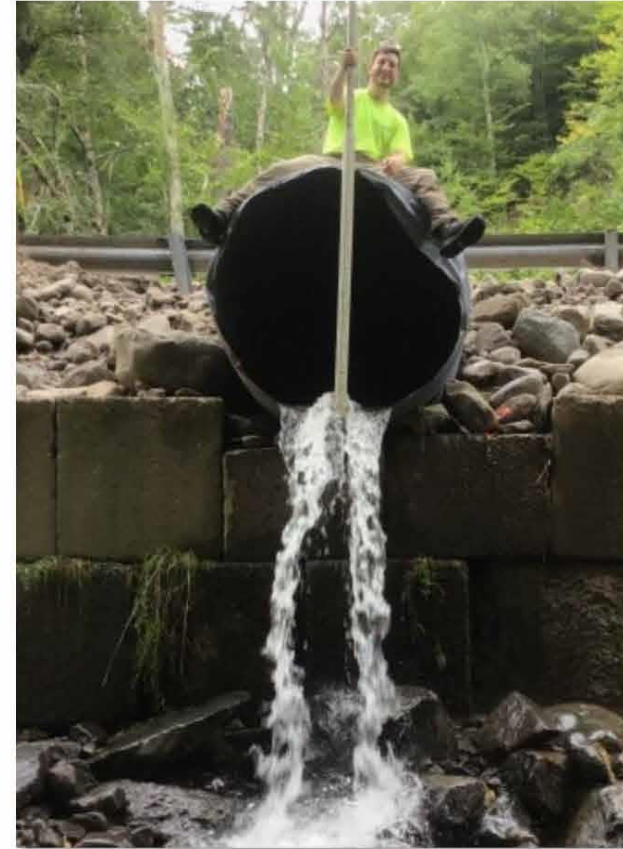

Developed by Tim Koch, 2018

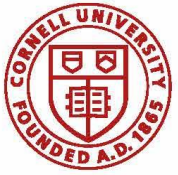

# Multi-Objective Stream Crossing Assessment Protocol (MOSCAP)

---

## Objectives

- Inventory road-stream crossings (RSX)
- Perform comprehensive, yet rapid field assessment
  - Geomorphic compatibility (GC)
  - Structural condition (SC)
  - Aquatic organism passage (AOP)
  - Flood flow capacity (FC)
- Objectively score and prioritize RSXs based on a suite of data and tailored to stakeholder priorities





# Multi-Objective Stream Crossing Assessment Protocol (MOSCAP)

Vermont Stream Geomorphic Assessment

## Appendix G



Bridge and Culvert Assessment

Vermont Agency of Natural Resources  
March, 2009

## Geomorphic Compatibility (GC)

- Does the structure influence or interfere with stream processes?
  - Erosion
  - Deposition
  - Sediment & debris continuity
  - Channel dimensions
  - Structure dimensions
  - Scour
  - Armoring







# Multi-Objective Stream Crossing Assessment Protocol (MOSCAP)

## Culvert Inventory and Inspection Manual

May 2006



New York State  
Department of Transportation

GEORGE E. PATAKI, Governor  
THOMAS J. MADISON, JR., Commissioner

### Structural Condition (SC)

- What physical condition are individual structural components in?
  - Pavement
  - Settlement
  - Embankment
  - Span Barrel
  - Abutment
  - Headwall
  - Wingwall







# Multi-Objective Stream Crossing Assessment Protocol (MOSCAP)

NAACC Stream Crossing Instruction Manual for Aquatic Passability Assessments in Non-tidal Stream and Rivers



North Atlantic Aquatic Connectivity Collaborative



Version 1.3 – June 2, 2019  
(for Data Form dated May 26, 2016)

#### CONTACTS

Scott Jackson  
Department of Environmental Conservation  
Holdsworth Hall  
University of Massachusetts  
Amherst, MA 01003  
(413) 545-4743; sjackson@umass.edu

Alex Abbott  
Gulf of Maine Coastal Program  
U.S. Fish and Wildlife Service  
4R Fundy Road  
Falmouth, ME 04105  
(207) 781-8364; alexoabbott@hotmail.com

For more information, go to: [www.streamcontinuity.org/naacc](http://www.streamcontinuity.org/naacc)

## Aquatic Organism Passage (AOP)

- Is the structure a barrier to the movement of aquatic & riparian species?
  - Outlet drop
  - Excessive velocity
  - Water depth
  - Lack of substrate







# Multi-Objective Stream Crossing Assessment Protocol (MOSCAP)



Cascade Brook @ Olivera Rd., post-Irene

## Flood Flow Capacity (FC)

- Is the structure undersized for expected flood flows?
  - Hydrology & Hydraulics
  - Desktop GIS analysis
  - Performed after field season

### The Cornell Culverts Model

Last Updated: 11/27/2018

Created by David Gold, edits: Allison Truhlar, Jo Archibald

Instructions for the CulvertModelFiles download (rename the folder with your project name)

Soil and Water Lab

Cornell University





# Multi-Objective Stream Crossing Assessment Protocol (MOSCAP)

## FIELD ASSESSMENT ORDER OF OPERATIONS

1. From road surface
2. Walking Upstream
3. Walking Back Towards Structure
4. At Structure Inlet
5. Inside the Structure
6. At Structure Outlet
7. Walking Downstream
8. Site Review
  - Verify ALL data has been collected
  - Verify ALL equipment has been gathered



## H. Detailed Flood Analyses (FEMA)

The following section provides detailed flood analyses (executed by FEMA) that overlap with the road-stream crossings assessed in this project.

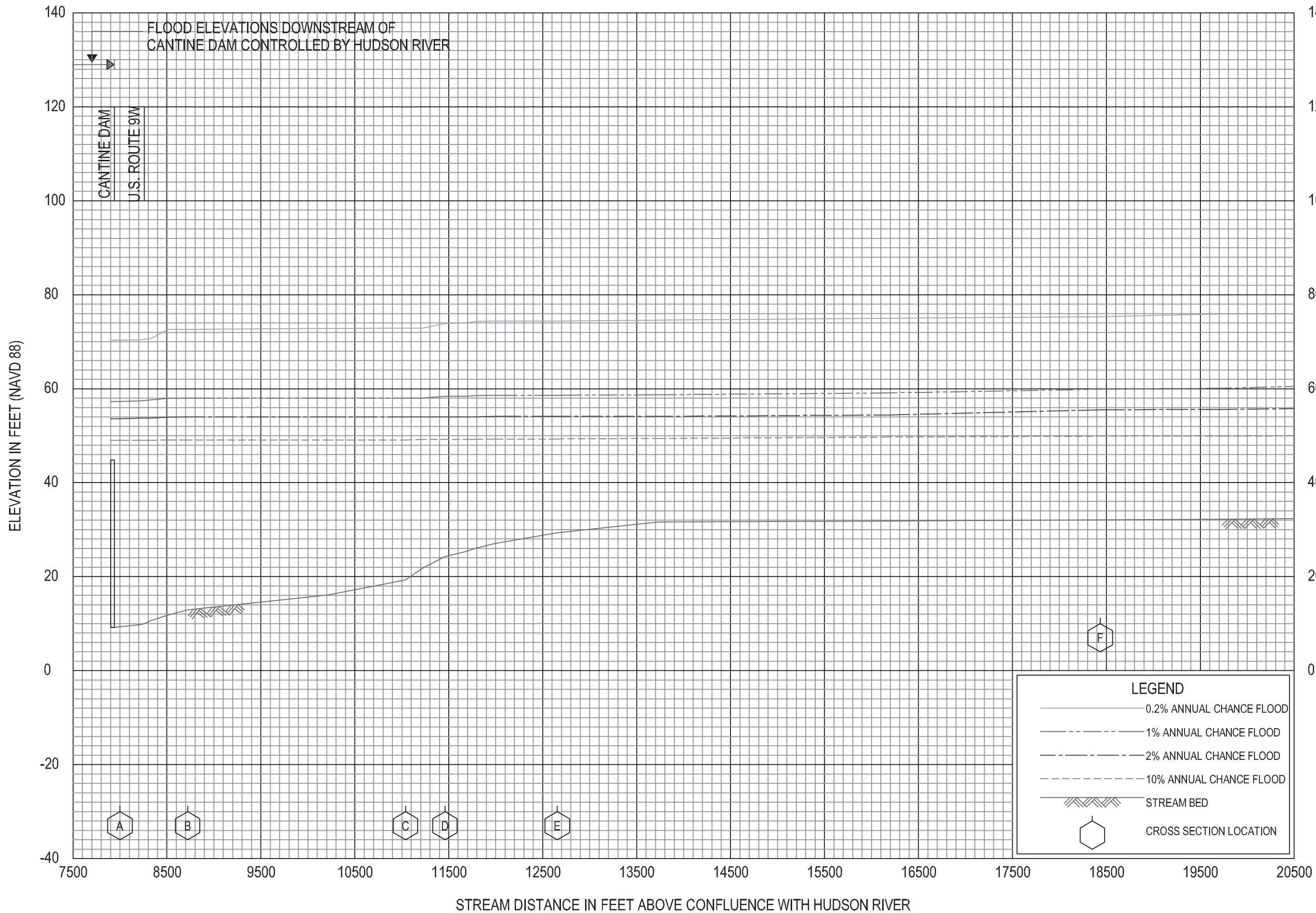

**LEGEND**

- 0.2% ANNUAL CHANCE FLOOD
- 1% ANNUAL CHANCE FLOOD
- 2% ANNUAL CHANCE FLOOD
- 10% ANNUAL CHANCE FLOOD
- STREAM BED
- CROSS SECTION LOCATION

**FLOOD PROFILES**

ESOPUS CREEK (REACH 1)

FEDERAL EMERGENCY MANAGEMENT AGENCY  
**ULSTER COUNTY, NY**  
(ALL JURISDICTIONS)

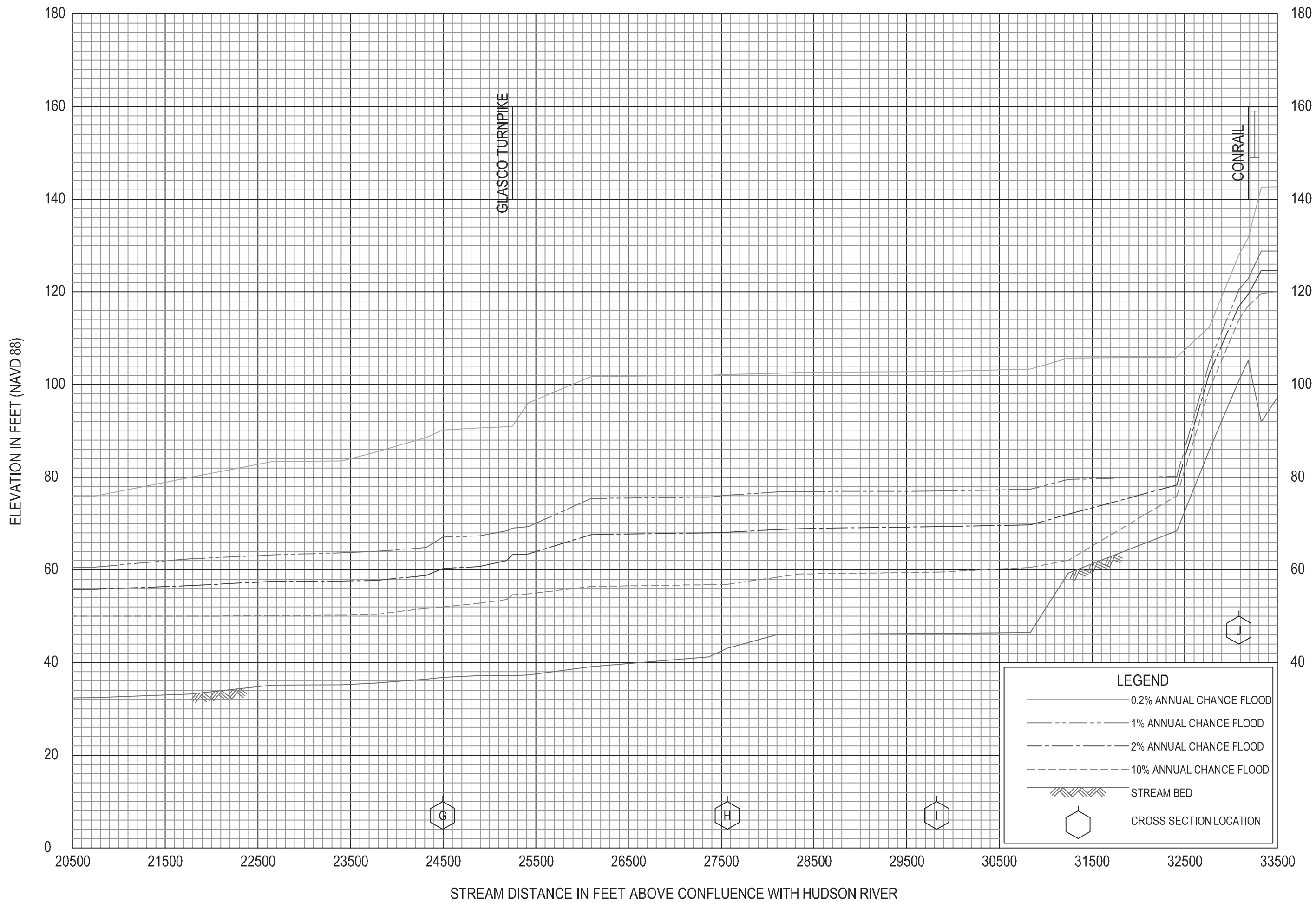

**FLOOD PROFILES**  
**ESOPUS CREEK (REACH 1)**

FEDERAL EMERGENCY MANAGEMENT AGENCY  
**ULSTER COUNTY, NY**  
 (ALL JURISDICTIONS)



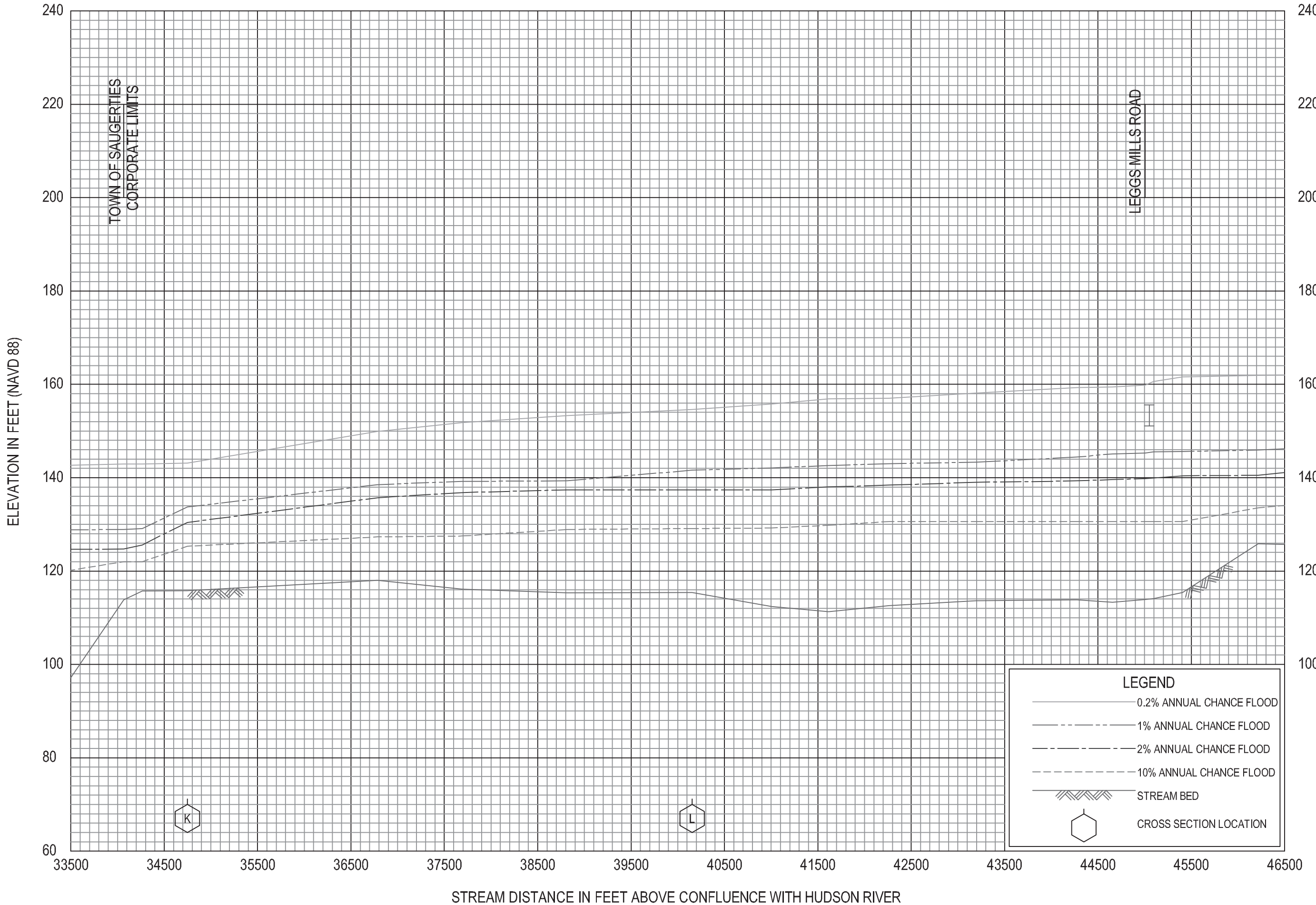

**FLOOD PROFILES**

**ESOPUS CREEK (REACH 1)**

FEDERAL EMERGENCY MANAGEMENT AGENCY

**ULSTER COUNTY, NY**  
(ALL JURISDICTIONS)



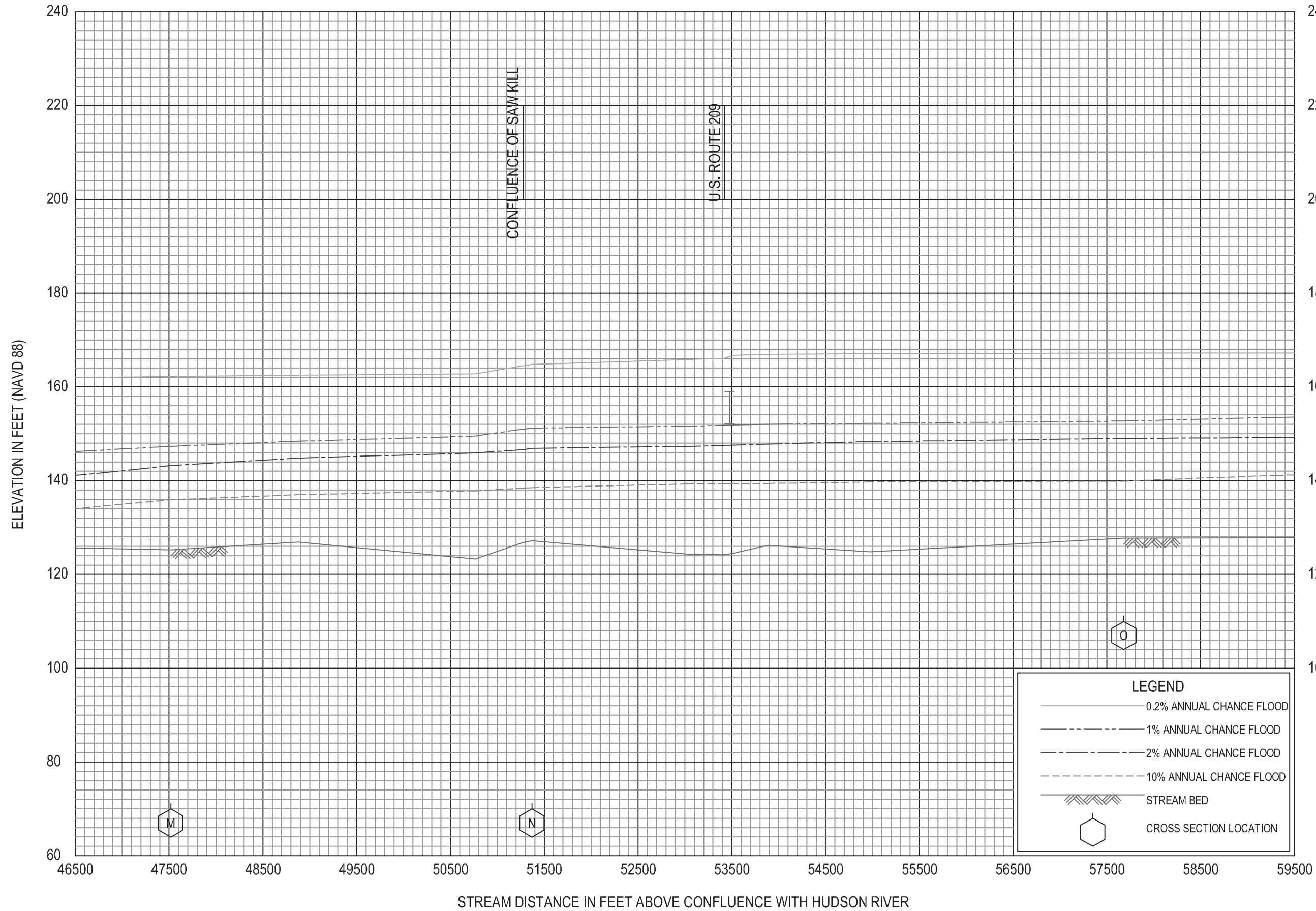

FLOOD PROFILES

ESOPUS CREEK (REACH 1)

FEDERAL EMERGENCY MANAGEMENT AGENCY

ULSTER COUNTY, NY

(ALL JURISDICTIONS)

ELEVATION IN FEET (NAVD 88)

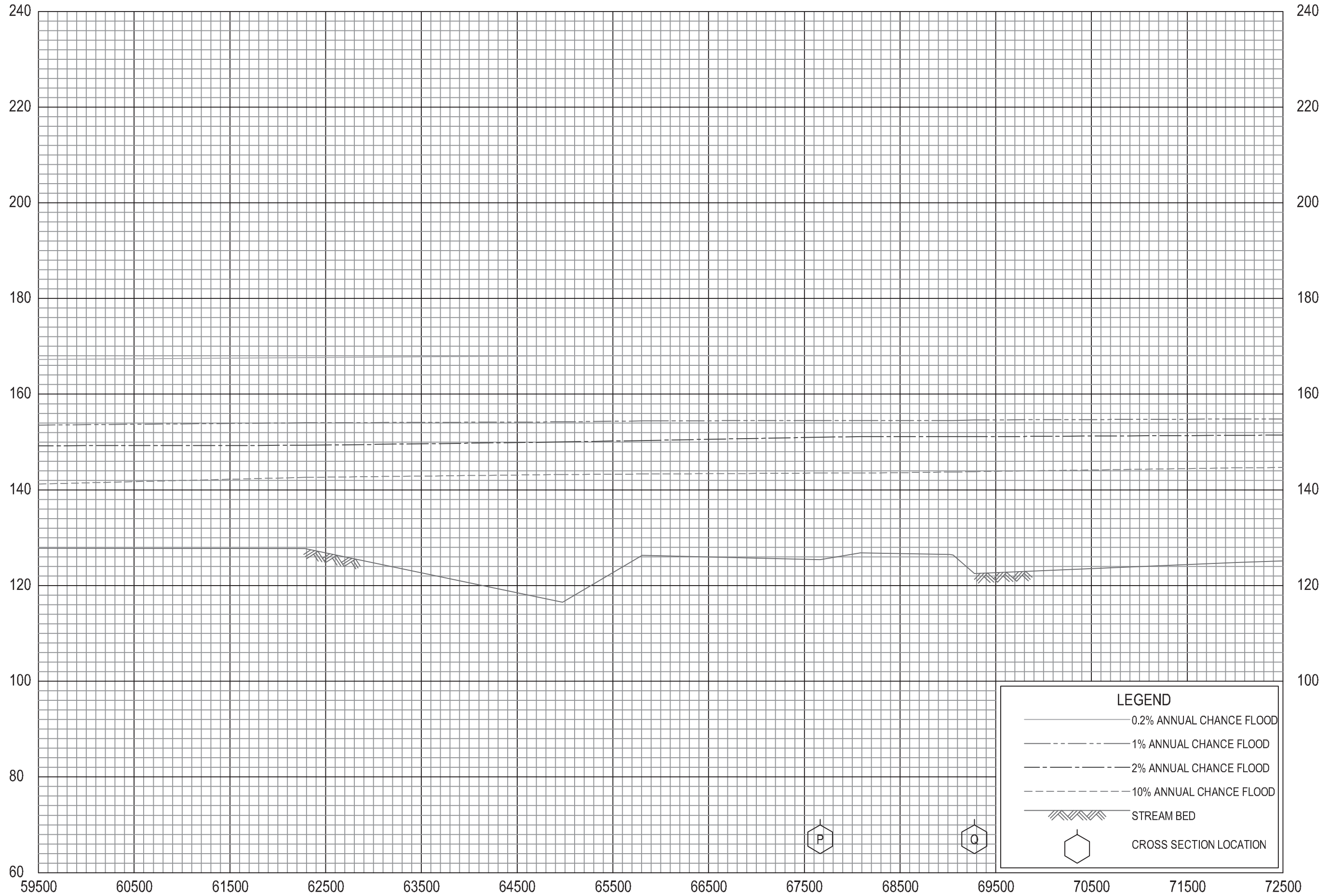

STREAM DISTANCE IN FEET ABOVE CONFLUENCE WITH HUDSON RIVER

FLOOD PROFILES

ESOPUS CREEK (REACH 1)

FEDERAL EMERGENCY MANAGEMENT AGENCY

ULSTER COUNTY, NY  
(ALL JURISDICTIONS)

ELEVATION IN FEET (NAVD 88)

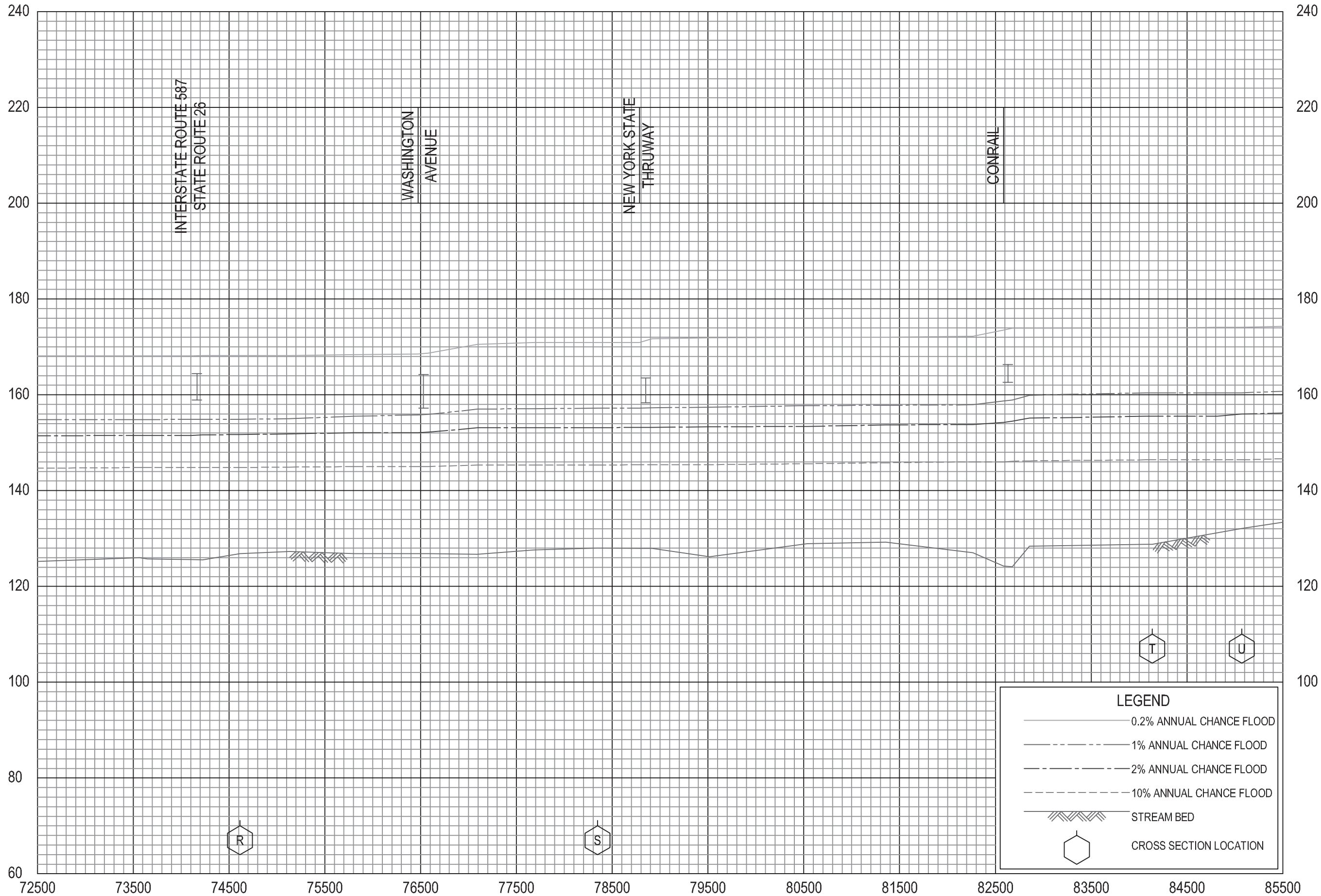

FLOOD PROFILES

ESOPUS CREEK (REACH 1)

FEDERAL EMERGENCY MANAGEMENT AGENCY  
ULSTER COUNTY, NY  
(ALL JURISDICTIONS)

ELEVATION IN FEET (NAVD 88)

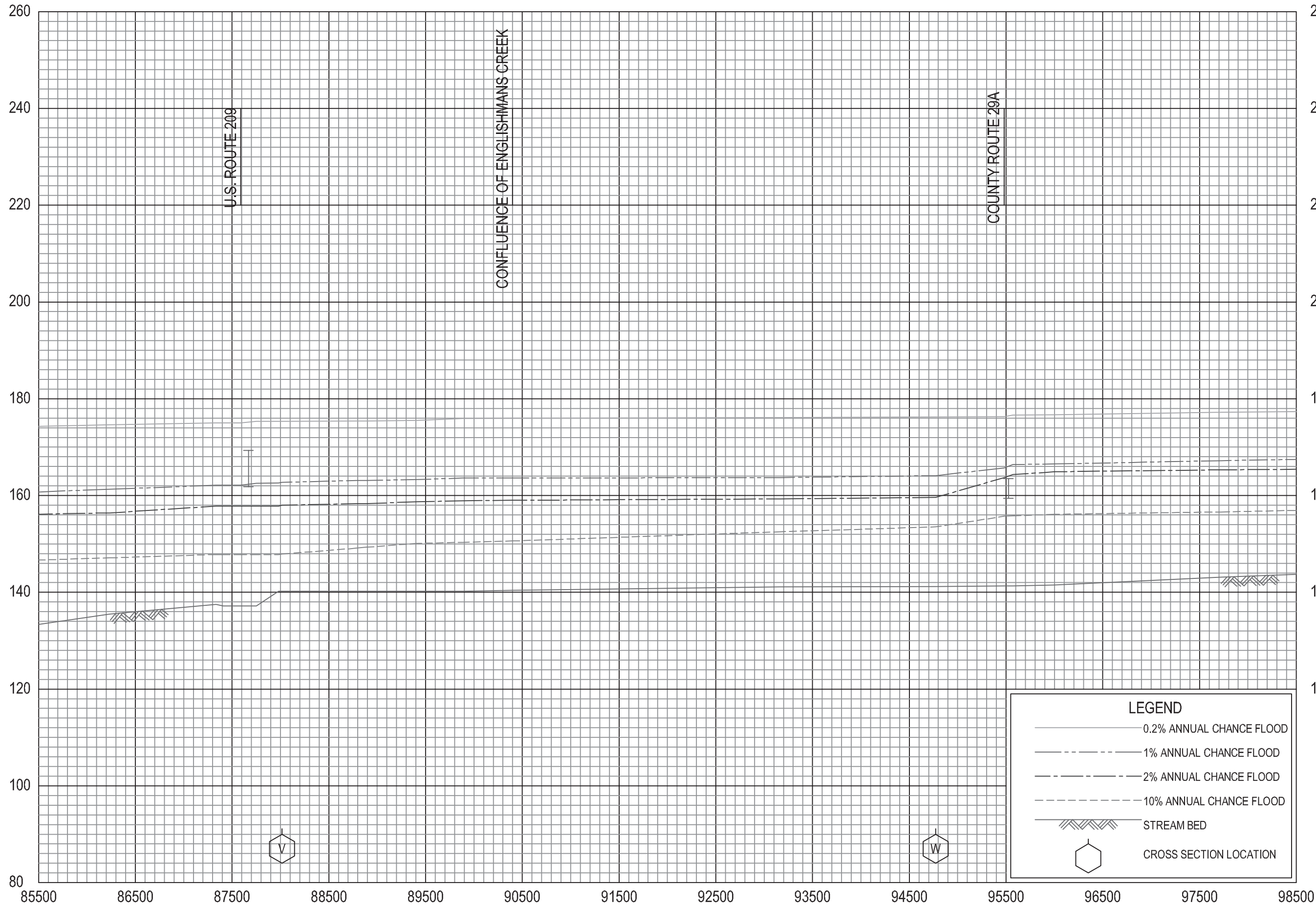

STREAM DISTANCE IN FEET ABOVE CONFLUENCE WITH HUDSON RIVER

**LEGEND**

- 0.2% ANNUAL CHANCE FLOOD
- 1% ANNUAL CHANCE FLOOD
- 2% ANNUAL CHANCE FLOOD
- 10% ANNUAL CHANCE FLOOD
- STREAM BED
- CROSS SECTION LOCATION

**FLOOD PROFILES**

ESOPUS CREEK (REACH 1)

FEDERAL EMERGENCY MANAGEMENT AGENCY  
**ULSTER COUNTY, NY**  
(ALL JURISDICTIONS)

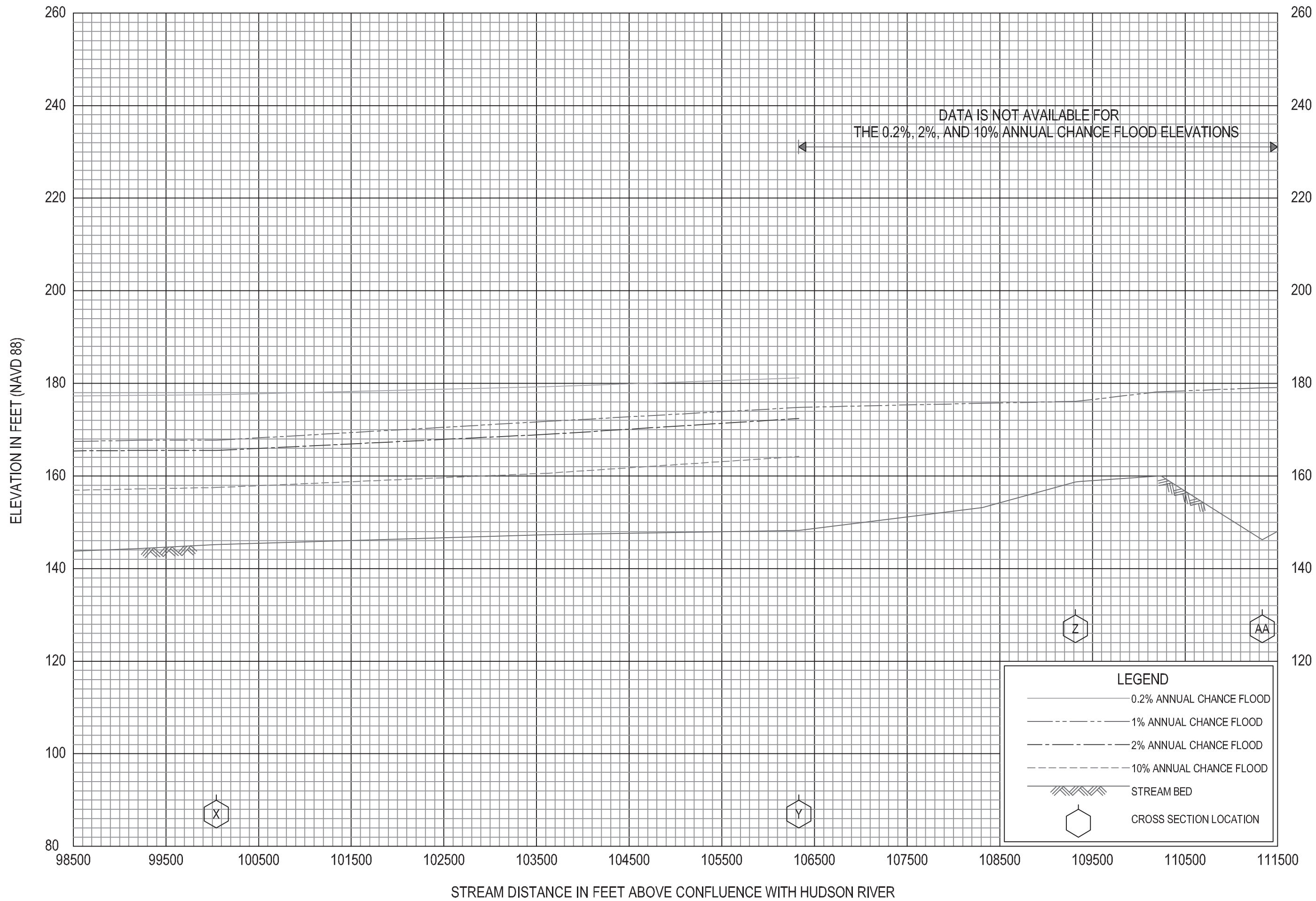

**FLOOD PROFILES**

**ESOPUS CREEK (REACH 1)**

FEDERAL EMERGENCY MANAGEMENT AGENCY

**ULSTER COUNTY, NY**  
(ALL JURISDICTIONS)



ELEVATION IN FEET (NAVD 88)

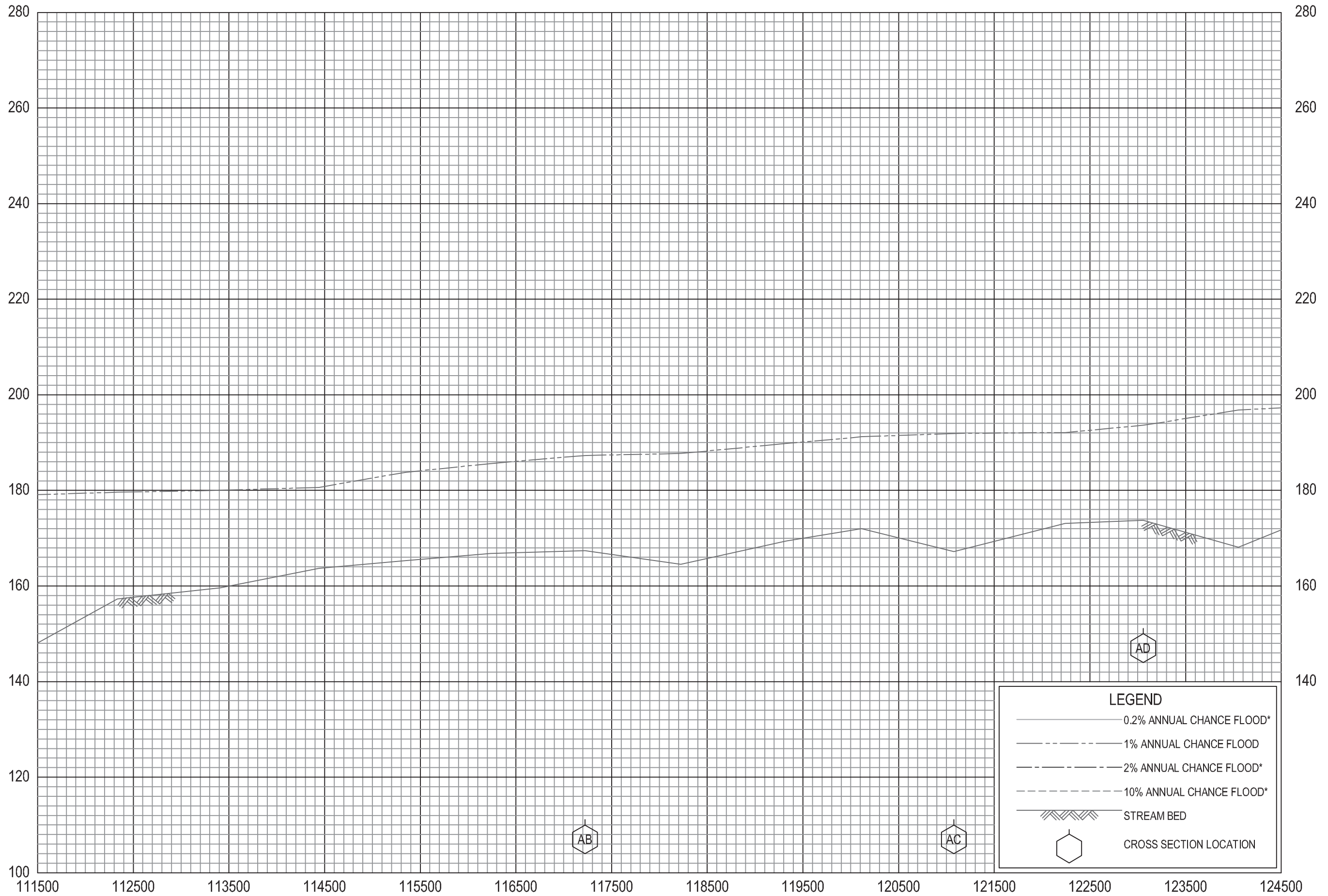

\*DATA NOT AVAILABLE

FLOOD PROFILES

ESOPUS CREEK (REACH 1)

FEDERAL EMERGENCY MANAGEMENT AGENCY

ULSTER COUNTY, NY  
(ALL JURISDICTIONS)

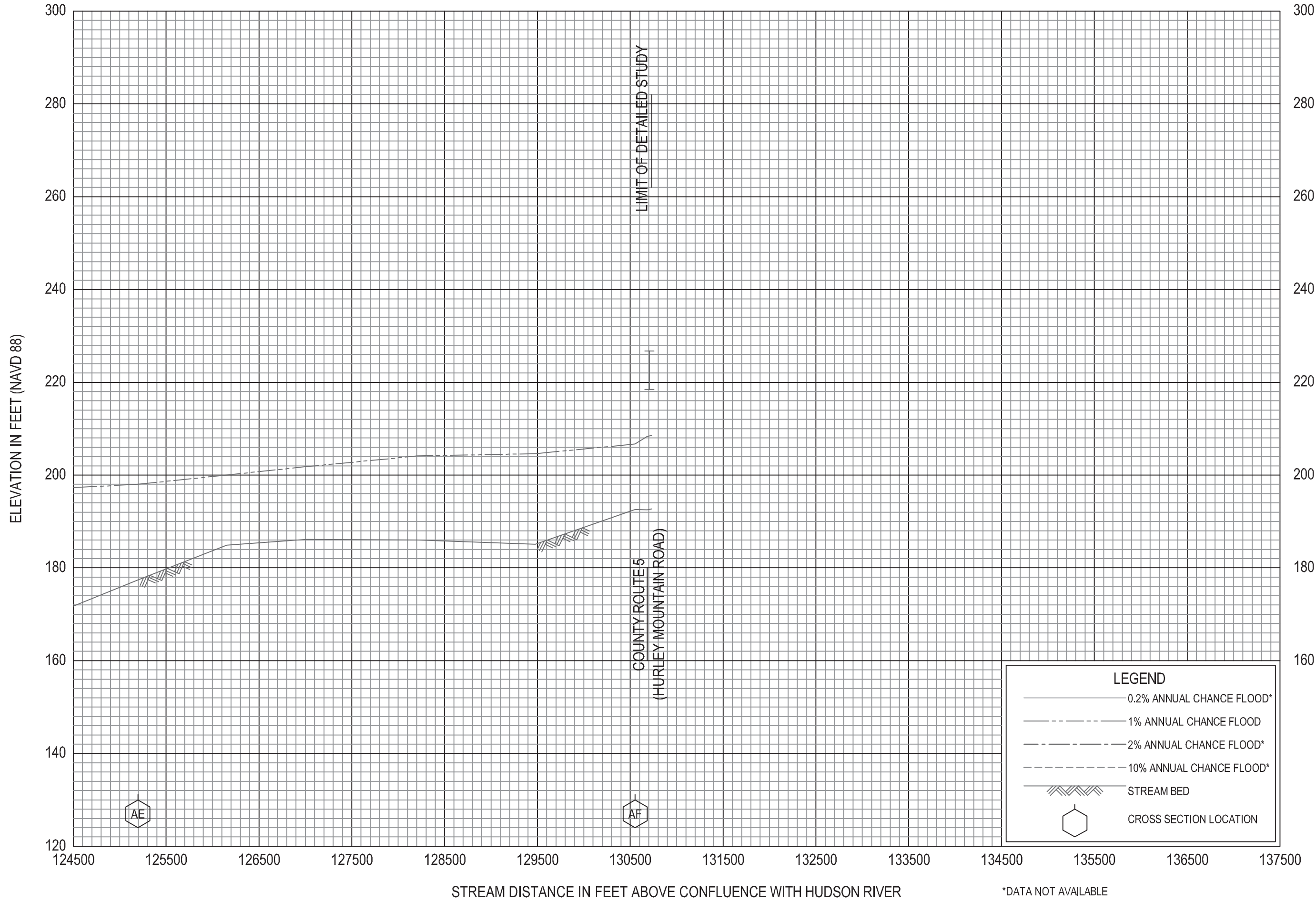

**FLOOD PROFILES**

**ESOPUS CREEK (REACH 1)**

FEDERAL EMERGENCY MANAGEMENT AGENCY

**ULSTER COUNTY, NY**  
(ALL JURISDICTIONS)

## I. HVA and LHCCD acknowledgement

# Acknowledgements

*Initial concept and all templates related to creation of the town-specific Road-Stream Crossing Management Plans were collaboratively developed by the Housatonic Valley Association (HVA) and the Lower Hudson Coalition of Conservation Districts (LHCCD).*



121 6th Ave #501  
New York, NY 10013

<https://www.lhccd.net/>

Contact:  
Michael Jastremski  
Coordinator  
mj.lhccd@gmail.com



150 Kent Rd S  
Cornwall Bridge, CT 06754

<https://hvatoday.org/>

Contact:  
Lindsay Larson  
Conservation Projects Manager  
Lkeenereck.hva@gmail.com

## J. Private Road-Stream Crossings

Predicted private road-stream crossings found by GIS desktop analysis are provided in the section below. These are approximate locations and have not been confirmed.

## **K. Dam Inventory**

Dams were located for each town by using ArcGIS to clip the NYSDEC dam inventory to town boundaries. Using NYSDEC Owners Guidance Manual for Inspection and Maintenance of Dams, one dam inspection survey was created and then implemented for each dam found within town boundaries. The dam inspection survey is a rapid visual assessment and should be used in conjunction with, not replacement of, an engineer's assessment. Photos were captured for each dam. Some dams were inaccessible and not assessed due to topography or private land. An inventory of each dam, along with history and other information provided by the NYSDEC dam inventory, is presented in the section below. If a dam was assessed, the assessment data and photos are provided as well.



# **Ulster County Dam Inventory**

## **(193-0826)**

Federal ID: NY14636

State ID: 193-0826

EAP Status: None

Coordinates: 41.90527778 -74.17277778

(193-0826) is located in the Town of Marbletown. Current owners are not known. It's construction type is other. It transports the Esopus Creek. It's dimensions are not known.

## **Springlake Dam**

Federal ID: NY13141

State ID: 193-0831

EAP Status: None

Coordinates: 41.92777778 -74.04111111

Springlake Dam is located in the City of Ulster and is owned by Charles Merrit. It is a construction type of masonry and located on Esopus Creek. It has a height of 12 ft and a length of 260 ft. It has an average storage of 7 ft<sup>3</sup> with a maximum storage of 8 ft<sup>3</sup>. The surface area is 2 ft<sup>2</sup> large. It consists of one spillway with uncontrolled overflow that is 5 ft wide. It's intended use is recreational.

## **Binnewater Reservoir Dam & Dike**

Federal ID: NY01130

State ID: 193-0863

EAP Status: On File 8/22/2016

Coordinates: 41.96783333 -74.01836111

Binnewater Reservoir Dam & Dike is located in the City of Ulster and is owned by the City of Kingston. It is an Earth type and is located on the Esopus Creek. It has a height of 30 ft and a length of 675 ft. The length of the dike is 170 ft. It has an average storage of 50 ft<sup>3</sup> with a maximum storage of 50 ft<sup>3</sup>. The surface area is 5 ft<sup>2</sup> large. It's primary use is recreational.

## **Old Mill Pond Dam**

Federal ID: NY13144

State ID: 193-2705

EAP Status: None

Coordinates: 41.9275 -74.20166667

Old Mill Pond Dam is located in the Town of Marbletown and is owned by the NYCDEP Dams West of the Hudson River. It is a concrete gravity and masonry type dam and is located on the Esopus Creek. It has a height of 16 ft and a length of 160 ft. It has a maximum discharge of 8,200 cfs with an average storage of 15 ft<sup>3</sup> and a maximum storage of 16 ft<sup>3</sup>. The surface area is 2.8 ft<sup>2</sup> and a drainage area of 8.5 ft<sup>2</sup>. The first spillway consists of a drop inlet or riser. The second inlet comprises of concrete overflow. The spillways have a width of 160 ft. It's primary use is recreational.

## L. Bibliography

American Rivers (2018, July 26). *How Dams Damage Rivers*. Retrieved October 02, 2020, from <https://www.americanrivers.org/threats-solutions/restoring-damaged-rivers/how-dams-damage-rivers/>

Federal Emergency Management Agency (2013, June), *Federal Guidelines for Inundation Mapping of Floods Risk Associated with Dam Incidents and Failures*. FEMA.

Forest Service Stream-Simulation Working Group (2008, August), *Stream Simulation: An Ecological Approach to Providing Passage for Aquatic Organisms at Road-Stream Crossings*. San Dimas, CA: National Technology and Development Program.

New York State Department of Environmental Conservation, *Green Infrastructure* Retrieved October 02, 2020 from <https://www.dec.ny.gov/public/915.html>

New York State Department of Environmental Conservation (1987, June), *An Owners Guidance Manual For the Inspection and Maintenance of Dams in New York State*. DEC Publication, Division of Water.

New York State Department of Transportation (May, 2006), *Culvert Inventory and Inspection Manual*. NYSDOT.

Tim Koch (2018) *Multi Objective Stream Crossing Protocol*. Ashokan Watershed Stream Management Program (Unpublished).